



M1-G HIGH VOLUME LOW PRESSURE (HVLP) GRAVITY FEED SPRAY GUN

GUN ASSEMBLY	GUN INLET	FLUID NOZZLE		AIR NOZZLE		FLUID NEEDLE	
PART NO.	PSI	MARKINGS	PART NO.	MARKINGS	PART NO.	MARKINGS	PART NO.
6924-0000-0	18	94 (1.4mm)	45-9400	93P	46-9300	ABSS	54-4382

TABLE OF CONTENTS

PG.	SECTION
1	Description
1	Installation & Assembly
2	Safety Precautions
3	Operation
3	Cup Cleaning
3	Gun Cleaning & Lubrication
3	Parts Replacement
4	Parts List, Gun
5	Parts List, Cup
6	Troubleshooting
7	Troubleshooting
8	Accessories

WARNING

Halogenated Hydrocarbon Solvents—for example: 1, 1, 1-trichloroethane and methylene chloride can react with the aluminum in this cup and cause an explosion hazard. Read the data sheet for the material you intend to spray. Do not use spray materials containing these solvents with this cup.

NOTE

If an air adjusting valve is used at the gun inlet, use Model HAV-500 or HAV-501. Some competitive adjusting valves have significant pressure drop that can adversely affect spray performance. Models HAV-500 and HAV-501 have minimal pressure drop, which is important for HVLP spraying.

2. Attach the gravity feed cup to the material inlet.

IMPORTANT: Before using this equipment, read all safety precautions on page 2 and instructions. Keep for future use.

DESCRIPTION, GUN

The high volume low pressure gravity feed M1-G guns are designed to apply a wide variety of finishing materials. These guns were manufactured to provide a maximum transfer efficiency by **limiting air cap pressure to 10 psi (complies with rules issued by SCAQMD and other air quality authorities).**

These guns will produce approximately 10 psi air cap pressure at the recommended gun inlet pressure. Air cap test kits are available (see Accessories) which can be utilized to set the exact air cap pressure.

DESCRIPTION, CUP

This cup is designed to be used with or without the disposable cup liner. The cup liner allows painting in any position and simplifies clean up.

This gravity feed cup is designed to work with the M1-G gravity feed spray guns. The cup is constructed from durable aluminum to provide trouble-free operation. The cup fluid fitting is electroless nickel plated brass. The disposable cup lid is recyclable and is constructed with recycled polyethylene. The lid has a unique drip check to prevent paint from dripping out of the vent in the lid.

INSTALLATION

NOTE

Protective coating and rust inhibitors have been used to keep the gun and cup in good condition prior to shipment. Before using, flush with solvents so that these materials will be removed from fluid passages.

For maximum transfer efficiency, **do not use more pressure than is necessary to atomize the material being applied.**

1. Connect the gun to a clean, moisture and oil free air supply using a hose size of at least 5/16" I.D. hose. **Do not use 1/4" I.D. hose.**

NOTE

When gun is triggered on, adjust regulated pressure to desired setting to provide a maximum of 10 psi at the air cap. **Do not use more pressure than is necessary to atomize the material being applied.** Excessive pressure will create additional overspray and reduce transfer efficiency.

NOTE

If quick connects are required, use **ONLY** high flow quick connects approved for HVLP use, such as HC-4419 and HC-4719. Other types will not flow enough air for proper gun operation.

ASSEMBLY OF CUP TO GUN

1. Install one of the blue cup gaskets.
2. Place this cup gasket in the fluid inlet of the gun body.
3. Place filter in cup outlet at this time if desired.
4. Assemble cup to gun and tighten hand tight.

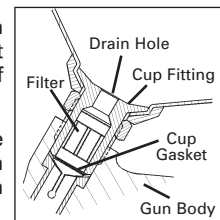

FILLING WITH PAINT

Fill the cup with paint to the full mark. **DO NOT OVERFILL.**

INSTALLING THE LID

Place plastic lid on the top of the cup, and **push in the center of the lid to assemble lid.** Fold vent cap and push onto center portion of lid (if vent cap is not already assembled).

SAFETY PRECAUTIONS

This manual contains information that is important for you to know and understand. This information relates to USER SAFETY and PREVENTING EQUIPMENT PROBLEMS. To help you recognize this information, we use the following symbols. Please pay particular attention to these sections.



Important safety information - A hazard that may cause serious injury or loss of life.







Important information that tells how to prevent damage to equipment, or how to avoid a situation that may cause minor injury.

NOTE

Information that you should pay special attention to.



The following hazards may occur during the normal use of this equipment. Please read the following chart before using this equipment.

HAZARD	CAUSE	SAFEGUARDS
Fire 	Solvent and coatings can be highly flammable or combustible especially when sprayed.	Adequate exhaust must be provided to keep air free of accumulations of flammable vapors. Smoking must never be allowed in the spray area. Fire extinguishing equipment must be present in the spray area.
Solvent Spray 	During use and while cleaning and flushing, solvents can be forcefully expelled from fluid and air passages. Some solvents can cause eye injury.	Wear eye protection.
Inhaling Toxic Substances 	Certain materials may be harmful if inhaled, or if there is contact with the skin.	Follow the requirements of the Material Safety Data Sheet supplied by your coating material manufacturer. Adequate exhaust must be provided to keep the air free of accumulations of toxic materials. Use a mask or respirator whenever there is a chance of inhaling sprayed materials. The mask must be compatible with the material being sprayed and its concentration. Equipment must be as prescribed by an industrial hygienist or safety expert, and be NIOSH approved.
Explosion Hazard - Incompatible Materials 	Halogenated hydrocarbon solvents - for example; methylene chloride and 1,1,1, - Trichloroethane are not chemically compatible with the aluminum that might be used in many system components. The chemical reaction caused by these solvents reacting with aluminum can become violent and lead to an equipment explosion.	Guns with stainless steel internal passageways may be used with these solvents. However, aluminum is widely used in other spray application equipment - such as material pumps, regulators, valves, and cups. Check all equipment items before use and make sure they can also be used safely with these solvents. Read the label or data sheet for the material you intend to spray. If in doubt as to whether or not a coating or cleaning material is compatible, contact your material supplier.
General Safety	Improper operation or maintenance of equipment.	Operators should be given adequate training in the safe use and maintenance of the equipment (in accordance with the requirements of NFPA-33, Chapter 15). Users must comply with all local and national codes of practice and insurance company requirements governing ventilation, fire precautions, operation, maintenance, and housekeeping. These are OSHA Sections 1910.94 and 1910.107 and NFPA-33.
Cumulative Trauma Disorders ("CTD's") CTD's, or musculoskeletal disorders, involve damage to the hands, wrists, elbows, shoulders, neck, and back. Carpal tunnel syndrome and tendonitis (such as tennis elbow or rotator cuff syndrome) are examples of CTD's.	Use of hand tools may cause cumulative trauma disorders ("CTD's"). CTD's, when using hand tools, tend to affect the upper extremities. Factors which may increase the risk of developing a CTD include: 1. High frequency of the activity. 2. Excessive force, such as gripping, pinching, or pressing with the hands and fingers. 3. Extreme or awkward finger, wrist, or arm positions. 4. Excessive duration of the activity. 5. Tool vibration. 6. Repeated pressure on a body part. 7. Working in cold temperatures. CTD's can also be caused by such activities as sewing, golf, tennis, and bowling, to name a few.	Pain, tingling, or numbness in the shoulder, forearm, wrist, hands, or fingers, especially during the night, may be early symptoms of a CTD. Do not ignore them. Should you experience any such symptoms, see a physician immediately. Other early symptoms may include vague discomfort in the hand, loss of manual dexterity, and nonspecific pain in the arm. Ignoring early symptoms and continued repetitive use of the arm, wrist, and hand can lead to serious disability. Risk is reduced by avoiding or lessening factors 1-7.

OPERATION

Turn on air supply and set gun inlet pressure to lowest recommended pressure for material being sprayed. Best atomization will occur with 10 PSIG air cap pressure. However, some materials can be sprayed at lower pressures, improving transfer efficiency.

If the finish is too sandy and dry, the material flow may be too low for the atomization air pressure being used.

If the finish sags, there is too much material flowing for the atomizing air pressure being used.

Both of the above can be corrected by increasing or decreasing the atomization air pressure or the material flow. Pattern width can be altered by turning the side port knob either clockwise to decrease the width or counterclockwise to increase the width.

IMPORTANT: This gun may be used with most common coating and finishing materials. It is designed for use with mildly corrosive and non-abrasive materials. If used with other high corrosive or abrasive materials, it must be expected that frequent and thorough cleaning will be required and the necessity for replacement of parts will be increased.

CUP CLEANING

NOTE

For routine cleaning, it is not necessary to remove cup from gun. Do not remove cup gasket from gun. If gasket is removed, it must be replaced.

CAUTION

Do not soak the lid in solvent for extended periods of time. Doing so could cause cup/lid sealing problems and leakage.

The cup lid is designed to be disposable, but may be cleaned and reused if slightly contaminated with overspray. **If lid becomes tight, or does not fit, it is due to extended soaking in solvent. Let lid air dry overnight and the lid should return to its original size and fit.**

1. Remove lid and properly dispose of any excess paint.
2. Pour in a small amount of clean solvent. The amount will vary with different coatings and solvents.
3. Reinstall lid. Hold lid with finger covering vent hole. Shake cup to wash down the inside surfaces.
4. Pull trigger to allow some solvent to be flushed through gun.
5. Remove lid and pour out dirty solvent. Add a small amount of clean solvent and repeat procedure.
6. Wipe exterior of lid with a clean cloth and clean solvent.

If a paint filter was used in the bottom of the cup outlet, it should be removed and cleaned or replaced at this time. Dispose of used cup lid if contaminated and replace with new.

GUN CLEANING

To clean air nozzle and fluid nozzle, brush exterior with a stiff bristle brush. If it is necessary to clean air nozzle holes, use a broom straw or toothpick if possible. **If a wire or hard instrument is used, extreme care must be used to prevent scratching or burring of the holes which will cause a distorted spray pattern.**

To clean fluid passages, remove excess material from the cup, then flush with a suitable solvent. Wipe gun exterior with a solvent-dampened cloth. Never completely immerse in solvent as this is detrimental to the lubricants and packings.

SPRAY GUN LUBRICATION

Use Binks Gunner's Mate lube to lubricate the areas shown below.

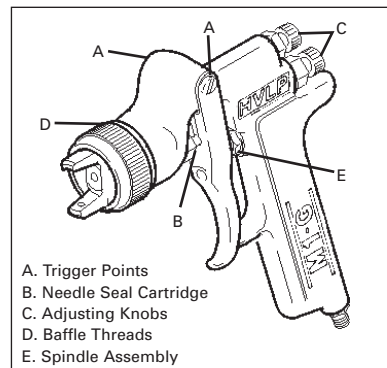

PARTS REPLACEMENT

Fluid Nozzle and Needle:

When replacing the fluid nozzle or fluid needle, replace **BOTH** at the same time. Using worn parts can cause fluid leakage. Also, replace the needle seal cartridge assembly at this time. Lightly lubricate the threads of the fluid tip before reassembling. Torque to 10-12 ft. lbs. Do not overtighten the fluid tip.

CAUTION

To prevent damage to fluid nozzle or fluid needle, be sure to either pull the trigger and hold while tightening or loosening the fluid tip.

Air Valve Assembly:

Remove material control knob, spring and fluid needle. Unscrew housing and remove spindle assembly with springs, seal retainers and o-rings. Lubricate new o-rings with Gunner's Mate. Assemble components using material needle. Place this assembly along with housing into gun body and screw into position. Remove material needle and tighten housing.

Cartridge Assembly (Needle Packing):

Remove material valve control knob, spring and fluid needle. Pull back trigger and remove seal cartridge assembly. Remove and discard plastic shipping pin in new cartridge assembly. Pull back trigger and insert new seal cartridge assembly. Reassemble needle assembly, spring and material valve control knob.

M1-G HVLP GRAVITY FEED GUN

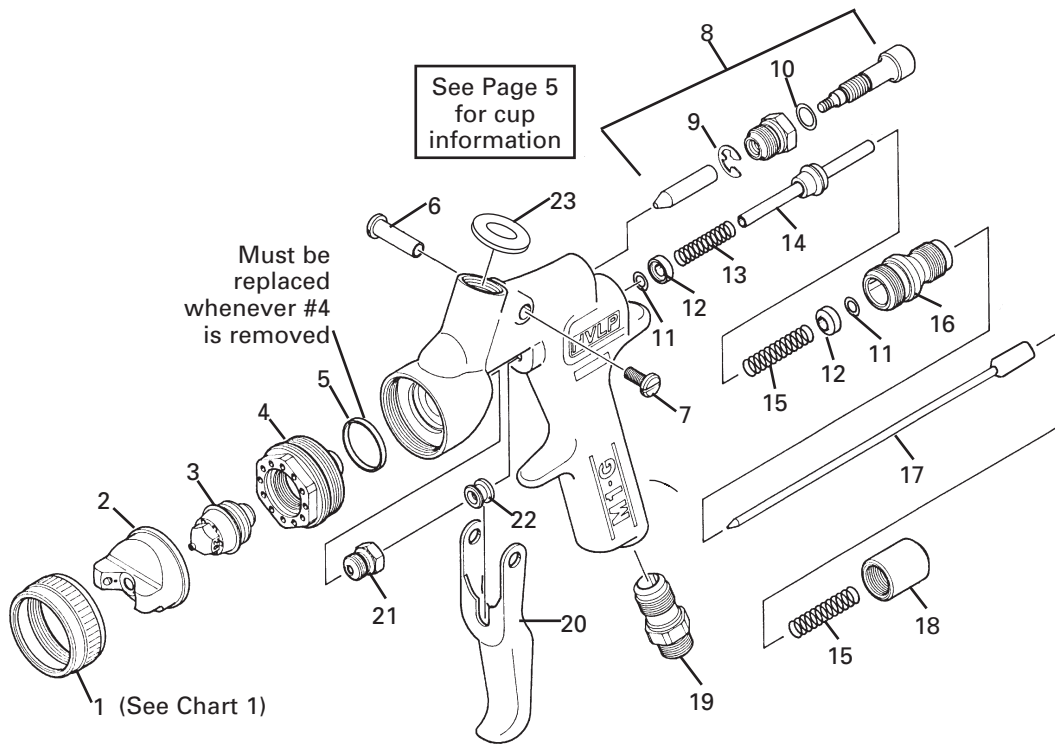

No.	Order No.	Description	Parts Required
1	54-3531	Retaining Ring (For 92P and 93P Air Nozzle)	1
2	46-9300	Air Cap	1
3	See Chart 1†	Fluid Nozzle	1
4	54-4368†	Head Insert	1
5	54-4369-5▲	Head Insert Seal Ring (Kit of 5)	1
6	●	Trigger Stud	1
7	●	Trigger Screw	1
8	54-4364†	Side Port Control Assembly	1
9	▲	Retaining Ring	1
10	▲	O-Ring	1
11	▲★	O-Ring	2
12	★	Seal Retainer	2
13	▲*	Spring, Yellow	1
14	54-3512▲	Spindle Assembly	1
15	▲*	Spring, Blue	2
16	54-3541†	Housing	1
17	See Chart 2	Fluid Needle	1
18	54-3606	Material Valve Control Knob	1
19	54-768†	Air Connection	1
20	54-4360	Trigger	1
21	54-4370▲	Seal Cartridge Assembly	1
22	●	Valve Spindle Cap	1
23	KGP-13-K5▲	Cup Gasket (Kit of 5)	1

Chart 1

Fluid Nozzle	Order No.	I.D. Size	
		In.	MM
92	45-9200	.046	1.2
93	45-9300	.052	1.3
94	45-9400	.055	1.4
97	45-9700	.070	1.8

Chart 2

Needle	Order No.
ABSS	54-4382

● Screw, Stud & Cap Kit (54-5223)		
No.	Description	Qty.
6	Trigger Stud	1
7	Trigger Screw	1
22	Valve Spindle Cap	1

▲ NOTE: Gun Repair Kit (54-4367-1) Contains:

Ref. No.	Description	Qty.
5	Seal	1
9	Retaining Ring	1
10	O-Ring	1
11	O-Ring	2
13	Spring, Yellow	1
14	Spindle	1
15	Spring, Blue	2
21	Seal Cartridge	1
23	Cup Gasket	1

† Torquing Information		
No.	Description	Torque
3	Fluid Nozzle	10-12 Ft. Lb.
4	Head Insert	20-23 Ft. Lb.
8	Side Port	4-6 Ft. Lb.
16	Housing	15-17 Ft. Lb.
19	Air Connection	15-17 Ft. Lb.

★ O-Ring & Retainer Kit (54-5224)		
No.	Description	Qty.
11	O-Ring	2
12	Seal Retainer	2

GFC-502 CUP

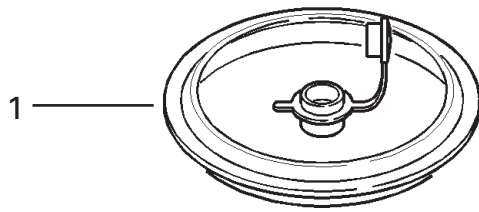

Ref. No.	Replacement Part No.	Description
	GFC-502	Metal Gravity Feed Cup*
1	GFC-404-K2	Disposable Lid Kit (Kit of 2)
2	KGP-5-K5	Filter Kit (Kit of 5)
3	KGP-13-K5	Cup Gasket (Blue) (Kit of 5)



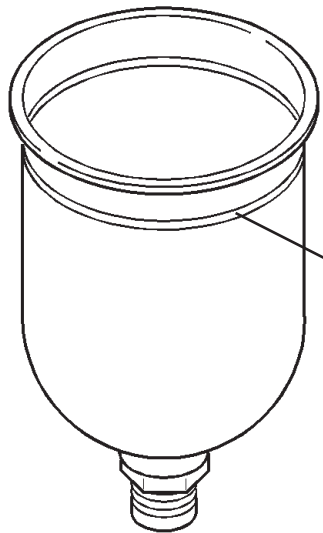

*Includes one each of Ref. Nos. 1, 2 and 3.

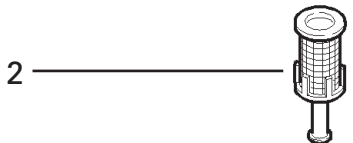

Full Mark



TROUBLESHOOTING

CONDITION	CAUSE	CORRECTION
Heavy top or bottom pattern 	Air nozzle horn holes plugged. Obstruction on top or bottom of fluid nozzle. Air nozzle and/or fluid nozzle seat dirty.	Clean with non-metallic point. Clean. Clean.
Heavy right or left side pattern 	Left or right side horn holes plugged. Dirt on left or right side of fluid nozzle. Remedies for the top-heavy, bottom-heavy, right-heavy, and left-heavy patterns: 1. Determine if the obstruction is on the air nozzle or the fluid nozzle. Do this by making a test spray pattern. Then, rotate the air nozzle one-half turn and spray another pattern. If the defect is inverted, obstruction is on the air nozzle. Clean the air nozzle as previously instructed. 2. If the defect is not inverted, it is on the fluid nozzle. Check for a fine burr on the edge of the fluid tip. Remove with #600 wet or dry sand paper. 3. Check for dried paint just inside the opening; remove by washing with solvent.	Clean with non-metallic point. Clean.
Heavy center pattern 	Fluid flow too high for atomization air. Material flow exceeds air nozzle's capacity. Side port adjustment valve set too low. Atomizing pressure too low. Material too thick.	Balance air pressure and fluid flow. Increase spray pattern width with spreader adjustment valve. Thin or lower fluid flow. Adjust. Increase pressure. Thin to proper consistency.
Split spray pattern 	Atomization air pressure too high. Fluid flow too low. Side port adjusting valve set too high.	Reduce at wall or gun. Increase fluid flow (increases gun handling speed). Adjust.
Jerky or fluttering spray 	*Loose or damaged fluid nozzle/seat. Material level too low. Container tipped too far. Obstruction in fluid passage.	Tighten or replace. Refill. Hold more upright. Backflush with solvent.
Unable to get round spray	Side port adjustment screw not seating properly. Air nozzle retaining ring loose.	Clean or replace. Tighten.
Will not spray	No air pressure at gun. Material adjusting knob not open enough. Fluid too heavy for gravity feed.	Check air supply and air lines, blow out gun air passages. Open material adjusting knob. Thin material and/or change to larger tip size.
Paint bubbles in cup	Fluid nozzle not tight.	Tighten fluid nozzle to 10-12 ft-lbs.
Fluid leaking or dripping from cup lid	Cup lid loose. Dirty threads on cup or lid. Cracked cup or lid.	Push in or tighten lid. Clean. Replace cup and lid.
Starved spray pattern	Inadequate material flow. Low atomization air pressure.	Back material adjusting knob or change to larger fluid nozzle size. Increase air pressure and rebalance gun.
Excessive overspray	Too much atomization air pressure. Gun too far from work surface. Improper stroking (arcing, gun motion too fast).	Reduce pressure. Adjust to proper distance. Move at moderate pace, parallel to work surface.
Excessive fog	Too much or too fast-drying thinner. Too much atomization air pressure.	Remix properly. Reduce pressure.
Dry spray	Air pressure too high. Gun tip too far from work surface. Gun motion too fast. Gun out of adjustment.	Reduce air pressure. Adjust to proper distance. Slow down. Adjust.
Fluid leaking from seal cartridge	Packing worn or dry.	Replace or lubricate.
Fluid leaking or dripping from front of gun	Dry seal cartridge. Fluid nozzle or needle worn or damaged. Foreign matter in fluid nozzle. Fluid needle spring broken. Wrong size needle or fluid nozzle.	Lubricate. Replace fluid nozzle and needle. Clean fluid nozzle. Replace. Replace.

*Most common problem.

TROUBLESHOOTING (continued)

CONDITION	CAUSE	CORRECTION
Fluid dripping or leaking from bottom of cup	Cup loose on gun. Cup gasket worn or missing below cup. Cup threads dirty.	Tighten. Replace cup gasket. Clean.
Runs and sags	Too much material flow. Material too thin. Gun tilted on an angle, or gun motion too slow.	Adjust gun or reduce fluid flow. Mix properly or apply light coats. Hold gun at right angle to work and adapt to proper gun technique.
Thin, sandy coarse finish drying before it flows out	Gun too far from surface. Too much air pressure. Improper thinner being used.	Check distance. Normally approx. 8". Reduce air pressure and check spray pattern. Follow paint manufacturer's mixing instrs.
Thick, dimpled finish "orange peel"	Gun too close to surface. Air pressure too low. Improper thinner being used. Material not properly mixed. Surface rough, oily, dirty.	Check distance. Normally approx. 8". Too much material coarsely atomized. Increase air pressure or reduce fluid flow. Follow paint manufacturer's mixing instrs. Properly clean and prepare.

ACCESSORIES

Automotive Refinish Quick Connects for HVLP Guns (Air) High Flow Type

HC-4419 Stem 1/4" NPT(F) HC-4719 Coupler 1/4" NPT(M)/NPS(M)

HC-1166 Stem 1/4" NPT(M) HC-4720 Coupler 1/4" NPT(F)

GFC-501 (Acetal) 20 oz. Cup
GFC-502 (Aluminum) 1 Liter Cup
Gravity Feed Cups

HAF-507 Whirlwind™ In-Line Air Filter

Removes water, oil and debris from the air line.

HAV-500 or HAV-501 (shown) Adjusting Valve

HAV-500 does not have pressure gauge. Use to control air usage at gun.

40-143 Large 40-128 Medium 40-141 Small Paint Spray Regulator

NIOSH-Certified (TC84A-1623) for respiratory protection in atmospheres not immediately dangerous to life.

192212 Professional Spray Gun Cleaning Kit

Contains six precision tools designed to effectively clean all DeVilbiss, Binks, Finishline and other brand spray guns.

54-4350 Mixing Bench Gun Holder

Gun holders are made to hold standard paint cups, gravity feed guns and cups, and paint filters.

192219 Gun Holder, Coated

Gun holder made to hold guns with gravity cups.

OMX-70-K48 Paint Cup Liner Kit

Allows quick & easy clean-up.

Consists of:
 1 Piercing Tool
 48 Disposable Liners
 48 Drain Bushings

192218 Scrubs® Hand Cleaner Towels

Scrubs® are a pre-moistened hand cleaner towel for painters, body men and mechanics that go where you go and no water is needed.

54-3918 Wrench

ITW Automotive Refinishing
 Binks has authorized distributors throughout the world. For equipment, parts and service, check the Yellow Pages under "Automotive Body Shop Equipment and Supplies." For technical assistance, see listing below.

U.S./Canada Customer Service Office:
 11360 S. Airfield Road, Swanton, OH 43558
 Toll-Free Telephone: 1-800-445-3988 (U.S.A. and Canada only)
 Toll-Free Fax: 1-800-445-6643

Binks Worldwide Sales and Service Listing: www.binks.com

WARRANTY
 This product is covered by Binks' 1 Year Limited Warranty.

