

FLG3 SUCTION FEED SPRAY GUNS

IMPORTANT: Before using this equipment, read all safety precautions on page 2 and instructions. Keep for future use.

DESCRIPTION

These guns are light weight, general purpose suction feed spray guns for conventional spraying applications suitable for use with a wide variety of common coating materials. They come complete with 1-quart metal suction cups.

The No. 1 (conventional) air cap requires a 10 CFM air supply at the gun inlet of approximately 40 psi, measured with the trigger pulled.



Halogenated hydrocarbon solvents - for example; 1, 1, 1-trichloroethane and methylene chloride - can chemically react with the aluminum in this gun and cause an explosion hazard. Read the label or data sheet for the material you intend to spray. Do not use spray materials containing these solvents with this spray gun.

IMPORTANT: This gun may be used with most common coating and finishing materials. It is designed for use with mildly corrosive and non-abrasive materials. If used with other high corrosive or abrasive materials, it must be expected that frequent and thorough cleaning will be required and the necessity for replacement of parts will be increased.

ASSEMBLY OF CUP TO GUN

1. Position yoke at right angle to gun body with vent hole in lid toward rear and lever of cam toward front of gun.
2. Fasten cup lid assembly to gun by attaching nut, see Figure 5, to fluid inlet nipple on gun. Tighten nut with wrench only until snug.

INSTALLATION

Note

Protective coating and rust inhibitors have been used to keep the gun in good condition prior to shipment. Before using the gun, flush it with solvents so that these materials will be removed from fluid passages.

For maximum transfer efficiency, **do not use more pressure than is necessary to atomize the material being applied.**

Connect the gun to a clean, moisture and oil free air supply using a hose size of at least **5/16" I.D.** hose. Do not use 1/4" I.D. hose. (25' x 1/4" hose at 18 CFM has a pressure loss of 25 psi. 25' x 5/16" hose at 18 CFM has a pressure loss of 8 psi.)

Note

If quick connects are required, use only high flow quick connects such as DeVilbiss HC-4419 and HC-4719. Other types will not flow enough air for proper gun operation.

Note

If an air adjusting valve is used at the gun inlet, use DeVilbiss Model HAV-500 or HAV-501. Some competitive adjusting valves have significant pressure drop that can adversely affect spray performance. Models HAV-500 and HAV-501 have minimal pressure drop.

OPERATION

Mix, prepare and strain the material to be sprayed according to the paint manufacturer's instructions.

Strain material through a 60 or 90 mesh screen before pouring into cup.

Engage pins on cup into yoke and tighten yoke by moving lever of cam clockwise.

PAINTING

Open the spreader adjustment valve (7) (Fan) by turning the valve stem counterclockwise.

Close the fluid needle adjusting knob (13) by turning clockwise.

Turn on air supply and set gun inlet pressure to 40 psi for conventional use. Some materials can be sprayed at lower pressures, improving transfer efficiency.

Spray a test area. Turn the fluid needle adjusting knob (13) counterclockwise until a full coat is obtained.

If the finish is too sandy and dry, the material flow may be too low for the atomization air pressure being used. Turn the fluid needle adjusting knob (13) counterclockwise to increase fluid flow.

If the finish sags, there is too much material flowing for the atomization air pressure being used. Turn the fluid needle adjusting knob (13) clockwise to decrease fluid flow.

Pattern width can be altered by turning spreader adjustment valve (7), either clockwise to decrease the width or counterclockwise to increase the width.

Adjust inlet air pressure to provide a uniform dispersion of atomized paint throughout the pattern. Keep air pressure as low as possible to minimize bounce-back and overspray. Excessive pressure will result in split spray patterns. Inadequate pressures will cause heavy centered patterns and poor atomization.

SAFETY PRECAUTIONS

This manual contains information that is important for you to know and understand. This information relates to USER SAFETY and PREVENTING EQUIPMENT PROBLEMS. To help you recognize this information, we use the following symbols. Please pay particular attention to these sections.



Important safety information – A hazard that may cause serious injury or loss of life.







Important information that tells how to prevent damage to equipment, or how to avoid a situation that may cause minor injury.

NOTE

Information that you should pay special attention to.



**The following hazards may occur during the normal use of this equipment.
Please read the following chart before using this equipment.**

HAZARD	CAUSE	SAFEGUARDS
Fire 	Solvent and coatings can be highly flammable or combustible especially when sprayed.	<p>Adequate exhaust must be provided to keep air free of accumulations of flammable vapors.</p> <p>Smoking must never be allowed in the spray area.</p> <p>Fire extinguishing equipment must be present in the spray area.</p>
Solvent Spray 	During use and while cleaning and flushing, solvents can be forcefully expelled from fluid and air passages. Some solvents can cause eye injury.	Wear eye protection.
Inhaling Toxic Substances 	Certain materials may be harmful if inhaled, or if there is contact with the skin.	<p>Follow the requirements of the Material Safety Data Sheet supplied by your coating material manufacturer.</p> <p>Adequate exhaust must be provided to keep the air free of accumulations of toxic materials.</p> <p>Use a mask or respirator whenever there is a chance of inhaling sprayed materials. The mask must be compatible with the material being sprayed and its concentration. Equipment must be as prescribed by an industrial hygienist or safety expert, and be NIOSH approved.</p>
Explosion Hazard - Incompatible Materials 	Halogenated hydrocarbon solvents - for example; methylene chloride and 1,1,1, - Trichloroethane are not chemically compatible with the aluminum that might be used in many system components. The chemical reaction caused by these solvents reacting with aluminum can become violent and lead to an equipment explosion.	Guns with stainless steel internal passageways may be used with these solvents. However, aluminum is widely used in other spray application equipment - such as material pumps, regulators, valves, and this gun and cup. Check all equipment items before use and make sure they can also be used safely with these solvents. Read the label or data sheet for the material you intend to spray. If in doubt as to whether or not a coating or cleaning material is compatible, contact your material supplier.
General Safety	Improper operation or maintenance of equipment.	Operators should be given adequate training in the safe use and maintenance of the equipment (in accordance with the requirements of NFPA-33, Chapter 15). Users must comply with all local and national codes of practice and insurance company requirements governing ventilation, fire precautions, operation, maintenance, and housekeeping. These are OSHA Sections 1910.94 and 1910.107 and NFPA-33.
Cumulative Trauma Disorders ("CTD's") CTD's, or musculoskeletal disorders, involve damage to the hands, wrists, elbows, shoulders, neck, and back. Carpal tunnel syndrome and tendonitis (such as tennis elbow or rotator cuff syndrome) are examples of CTD's.	<p>Use of hand tools may cause cumulative trauma disorders ("CTD's").</p> <p>CTD's, when using hand tools, tend to affect the upper extremities. Factors which may increase the risk of developing a CTD include:</p> <ol style="list-style-type: none"> 1. High frequency of the activity. 2. Excessive force, such as gripping, pinching, or pressing with the hands and fingers. 3. Extreme or awkward finger, wrist, or arm positions. 4. Excessive duration of the activity. 5. Tool vibration. 6. Repeated pressure on a body part. 7. Working in cold temperatures. <p>CTD's can also be caused by such activities as sewing, golf, tennis, and bowling, to name a few.</p>	Pain, tingling, or numbness in the shoulder, forearm, wrist, hands, or fingers, especially during the night, may be early symptoms of a CTD. Do not ignore them. Should you experience any such symptoms, see a physician immediately. Other early symptoms may include vague discomfort in the hand, loss of manual dexterity, and nonspecific pain in the arm. Ignoring early symptoms and continued repetitive use of the arm, wrist, and hand can lead to serious disability. Risk is reduced by avoiding or lessening factors 1-7.

CLEANING

Air Pressure: Always clean with reduced air pressure. An air pressure no greater than 15 to 20 psi will allow quick and thorough cleaning of the cup and gun and at the same time will minimize the amount of solvent atomized into the air.

Cleaning Procedure:

1. Empty paint from cup and add small amount of clean solvent. The amount required will vary with different coatings and solvents.
2. Shake cup to wash down inside surfaces. Then spray solvent at low air pressure (15-20 psi) to flush out fluid passages.
3. Pour out solvent and add same amount of clean solvent.
4. Again, shake cup and respray to flush out fluid passages.
5. Wipe gun exterior with a solvent dampened cloth. Never completely immerse gun in solvent as this is detrimental to the lubricants and packings.
6. To clean air cap and fluid tip, brush exterior with a stiff bristle brush. If necessary to clean cap holes, use a broom straw or toothpick if possible. If a wire or hard instrument is used, extreme care must be used to prevent scratching or burring of the holes which will cause a distorted spray pattern.
7. Since all materials in the cup are highly solvent resistant, the cup assembly may be immersed for cleaning. Immersion should not exceed 24 hours. The use of paint strippers should be avoided because strippers will affect the aluminum as well as other nonmetallic components. If the lid gasket has become swollen from prolonged exposure to solvents, it will return to its original size without loss of properties when allowed to dry.
8. For routine cleaning, it is not necessary to remove the lid gasket.
9. Pry the splash shield loose from the bottom of the lid and wipe clean with a solvent soaked rag. Reinstall.

PREVENTIVE MAINTENANCE

Spray Gun Lubrication

Daily, apply a drop of SSL-10 spray gun lube at trigger bearing stud (21) and the stem of the air valve (14). The shank of the fluid needle (11) where it enters the packing nut (24) should also be oiled. The fluid needle packing (23) should be kept soft and pliable by periodic lubrication. Make sure the baffle (6) and retaining ring (1) threads are clean and free of foreign matter. Before assembling retaining ring to baffle, clean the threads thoroughly, then add two drops of SSL-10 spray gun lube to threads. The fluid needle spring (12) and air valve spring (15) should be coated with a very light grease, making sure that any excess grease will not clog the air passages. For best results, lubricate the points indicated, daily.

- A. Trigger Points
- B. Packing
- C. Adjusting Valves
- D. Baffle/Air Cap Threads

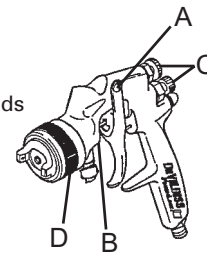

PARTS REPLACEMENT

Note

When replacing the fluid tip or fluid needle, replace both at the same time. Using worn parts can cause fluid leakage. Also, replace the needle packing and fluid tip seal at this time. Lightly lubricate the threads of the fluid tip before reassembling. Torque to 15-20 ft-lbs. Do not over-tighten the fluid tip.

The tip size is stamped on the hex of the fluid tip (#3). The fluid tip part number and tip size are also stamped around the outside of the fluid tip.

See Chart 2 for selecting the proper size fluid tip for the material you are spraying.



To prevent damage to the fluid tip (3) or fluid needle (11), be sure to either 1) pull the trigger and hold while tightening or loosening the fluid tip or 2) remove fluid needle adjusting screw (13) to relieve spring pressure against needle collar.

Chart 1 – Air Caps

Air Cap (Ref. No. 2) Computer		Application
Part No.	No.	
FLG-1-1	690000	Conventional

Chart 2 – Fluid Tips

Fluid Tip (Ref. No. 5) Computer		Fluid Tip Size (in.)	Fluid Tip Size (mm)	Applications
Part No.	No.			
FLG-302-13K*	690032	0.051	1.3	Stains, lacquers, basecoats, clears.
FLG-302-15K	690018	0.059	1.5	General purpose, light to medium viscosity material.
FLG-302-18K*	690033	0.070	1.8	Primers and medium viscosity materials.
FLG-302-22K*	690019	0.086	2.2	Latex and heavy materials.

*Optional tips for FLG3 guns available as service parts only.

Figure 4 Gun Drawing

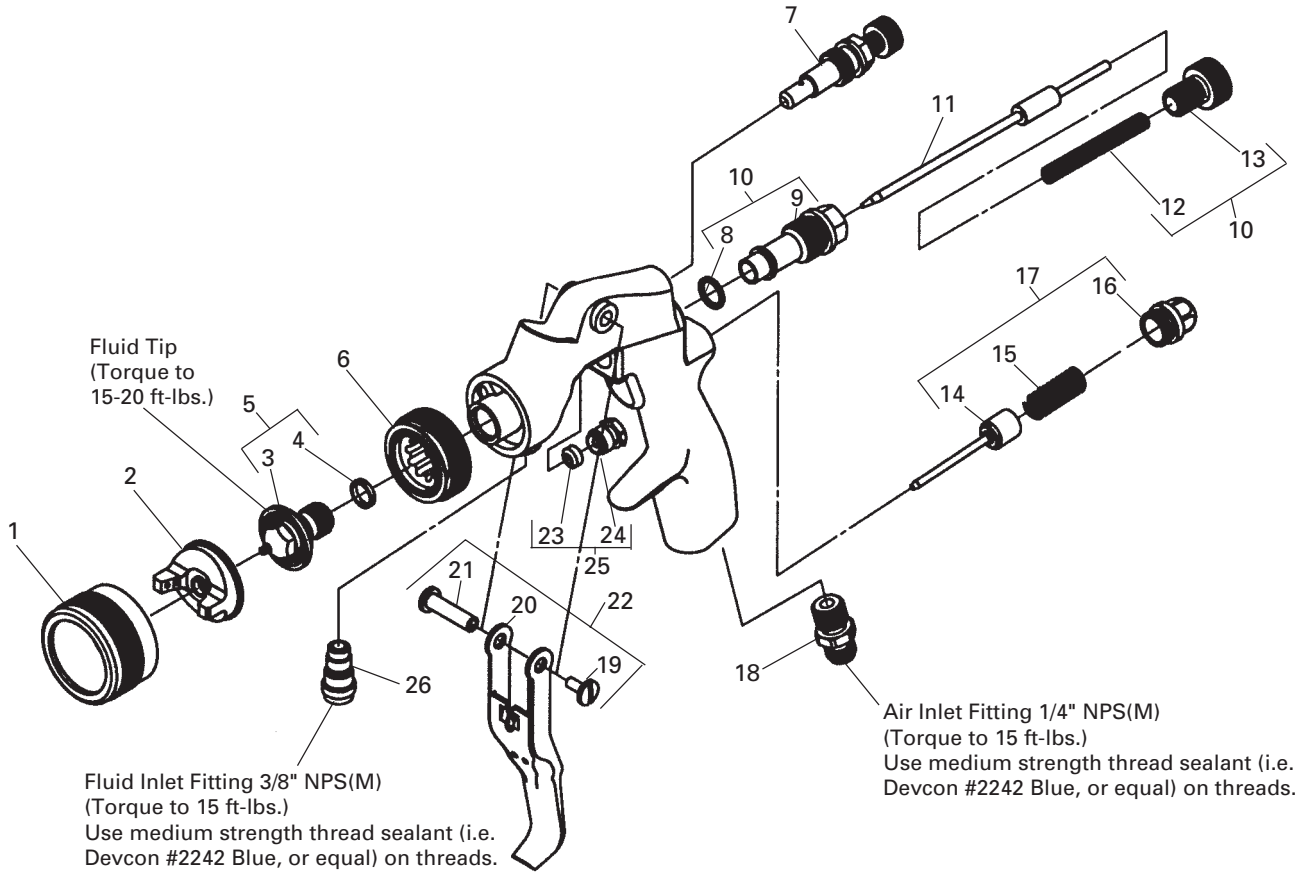

PARTS LIST



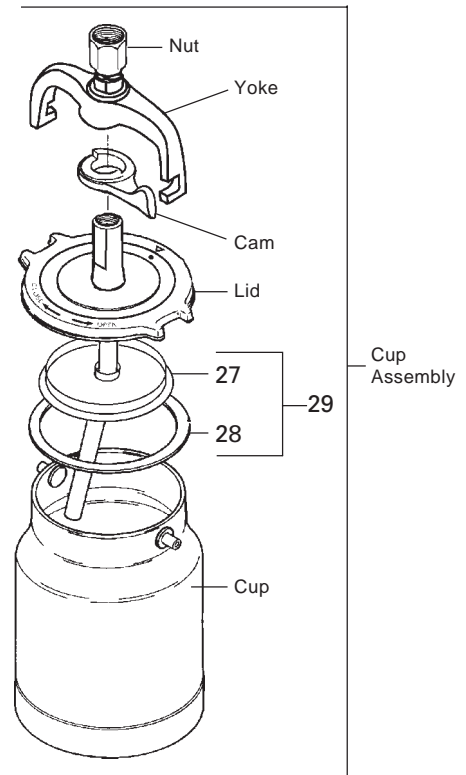

Ref. No.	Replacement Part No.	Description	Ind. Parts Required
1	FLG-301	Retaining Ring	1
2	See Chart 1	Air Cap	1
3	---	Fluid Tip	1
*4	FLG-304-K5	Fluid Tip Seal (Kit of 5)	1
5	See Chart 2	Fluid Tip & Seal Kit	1
6	FLG-305	Baffle	1
7	FLG-308	Spreader Adjustment Valve	1
*8	---	Seal	1
9	---	Bushing	1
10	FLG-483	Seal, Bushing, Spring, & Knob Kit	1
11	FLG-311	Fluid Needle	1
*12	---	Needle Spring	1
13	---	Needle Adjusting Knob	1
*14	---	Air Valve	1
*15	---	Air Valve Spring	1
16	---	Air Valve Cap	1
17	FLG-487	Air Valve Kit	1
18	FLG-322	Air Inlet Fitting	1
*19	---	Trigger Screw	1
20	---	Trigger	1
*21	---	Trigger Stud	1
22	FLG-485	Trigger, Stud & Screw Kit	1
*23	---	Needle Packing	1
24	---	Needle Packing Nut	1
25	FLG-484	Needle Packing & Nut Kit (3 Packings & 1 Nut)	1
26	FLG-330	Fluid Inlet Fitting	1
27	---	Splash Shield	1
28	---	Lid Gasket	1
29	FLG-489	Gasket & Splash Shield Kit	Cam

* A quantity of necessary parts is included in Repair Kit FLG-488 (Computer No. 690031) for complete gun repair and should be kept on hand for service convenience.

Figure 5 - Cup Drawing



TROUBLESHOOTING

CONDITION	CAUSE	CORRECTION
Heavy top or bottom pattern 	Horn holes plugged. Obstruction on top or bottom of fluid tip. Cap and/or tip seat dirty.	Clean. Ream with non-metallic point. Clean. Clean.
Heavy right or left side pattern 	Left or right side horn holes plugged. Dirt on left or right side of fluid tip. Remedies for the top-heavy, bottom-heavy, right-heavy, and left-heavy patterns: 1. Determine if the obstruction is on the air cap or the fluid tip. Do this by making a test spray pattern. Then, rotate the cap one-half turn and spray another pattern. If the defect is inverted, obstruction is on the air cap. Clean the air cap as previously instructed. 2. If the defect is not inverted, it is on the fluid tip. Check for a fine burr on the edge of the fluid tip. Remove with #600 wet or dry sand paper. 3. Check for dried paint just inside the opening; remove by washing with solvent.	Clean. Ream with non-metallic point. Clean.
Heavy center pattern 	Fluid flow too high for atomization air. Material flow exceeds air cap's capacity. Spreader adjustment valve set too low. Atomizing pressure too low. Material too thick.	Turn in fluid adjusting knob or reduce tip size. Increase spray pattern width with spreader adjustment valve. Thin or lower fluid flow. Adjust. Increase pressure. Thin to proper consistency.
Split spray pattern 	Fluid adjusting knob turned in too far. Atomization air pressure too high. Spreader adjusting valve set too high.	Back out counterclockwise to achieve proper flow. Reduce at transformer or gun. Adjust.
Jerky or fluttering spray 	*Loose or damaged fluid tip/seat. Material level too low. Container tipped too far. Obstruction in fluid passage. Loose or broken fluid tube or fluid inlet nipple. Dry or loose fluid needle packing nut.	Tighten or replace. Refill. Hold more upright. Backflush with solvent. Tighten or replace Lubricate or tighten.
Unable to get round spray	Fan adjustment screw not seating properly. Air cap retaining ring loose.	Clean or replace. Tighten.
Will not spray	No air pressure at gun. Fluid needle adjusting screw not open enough. Fluid too heavy for suction feed.	Check air supply and air lines. Open fluid needle adjusting screw. Thin material and/or change to larger tip size.
Starved spray pattern	Inadequate material flow. Low atomization air pressure.	Back fluid adjusting screw out to first thread, or change to larger tip size. Increase air pressure and rebalance gun.
Excessive overspray	Too much atomization air pressure. Gun too far from work surface. Improper stroking (arcing, gun motion too fast).	Reduce pressure. Adjust to proper distance. Move at moderate pace, parallel to work surface.
Excessive fog	Too much or too fast-drying thinner. Too much atomization air pressure.	Remix properly. Reduce pressure.
Dry spray	Air pressure too high. Gun tip too far from work surface. Gun motion too fast. Gun out of adjustment.	Decrease air pressure. Adjust to proper distance. Slow down. Adjust.

*Most common problem.

TROUBLESHOOTING (continued)

CONDITION	CAUSE	CORRECTION
Fluid leaking from packing nut	Packing nut loose. Packing worn or dry.	Tighten, do not bind needle. Replace or lubricate.
Fluid leaking or dripping from front of gun	Packing nut too tight. Dry packing. Fluid tip or needle worn or damaged. Foreign matter in tip. Fluid needle spring broken. Wrong size needle or tip.	Adjust Lubricate. Replace tip & needle. Clean. Replace. Replace.
Runs and sags	Too much material flow. Material too thin. Gun tilted on an angle or gun motion too slow.	Adjust gun or reduce tip size. Mix properly or apply light coats. Hold gun at right angle to work and adapt to proper gun technique
Thin, sandy coarse finish drying before it flows out	Gun too far from surface. Too much air pressure. Improper thinner being used.	Check distance. Normally 6-8". Reduce air pressure and check spray pattern. Follow paint manufacturer's mixing instructions.
Thick, dimpled finish "orange peel".	Gun too close to surface. Too much material coarsely atomized. Air pressure too low. Improper thinner being used. Material not properly mixed. Surface rough, oily, dirty.	Check distance. Normally 6-8". Turn in fluid adjusting screw or change to a smaller tip size. Increase air pressure or reduce fluid flow. Follow paint manufacturer's mixing instructions. Follow paint manufacturer's mixing instructions. Properly clean and prepare.

NOTES

ACCESSORIES

192212 Professional Spray Gun Cleaning Kit



Contains six precision tools designed to effectively clean all DeVilbiss, Binks, Finishline and other brand spray guns.

HAF-507 Whirlwind™ In-Line Air Filter

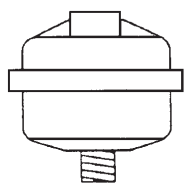

Removes water, oil, and debris from the air line.

HARG-510 Air Regulator

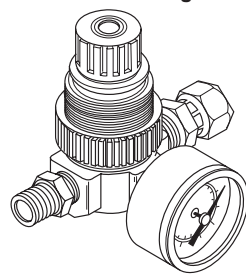

Use to maintain nearly constant outlet pressure despite changes in inlet pressure and downstream flow.

HAV-500 OR HAV-501 Adjusting Valve (HAV-501 SHOWN)

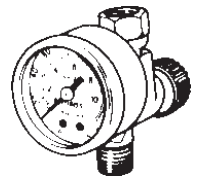

HAV-500 does not have pressure gauge. Use to control air usage at gun.

Automotive Quick Connects For HVLP Guns (Air) High Flow Type.

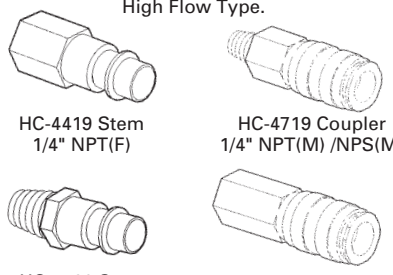

HC-4419 Stem 1/4" NPT(F) HC-4719 Coupler 1/4" NPT(M) /NPS(M)
 HC-1166 Stem 1/4" NPT(M) HC-4720 Coupler 1/4" NPT(F)

Spray Gun Lube SSL-10 (2 oz. bottle)



Compatible with all paint materials; contains no silicone or petroleum distillates to contaminate paint. MSDS available upon request.

MSP-524 Twin Cartridge, Paint Spray Respirator



NIOSH-Certified (TC84A-1623) for respiratory protection in atmospheres not immediately dangerous to life.

WR-103 Wrench

Contains all necessary tip, hose and nut sizes used on or with gun.

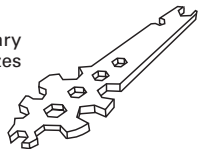

TGC-545 Aluminum Drip Free Suction Cups

Cups have a unique, two position valve which permits selection of either a drip free or conventional open vent mode.

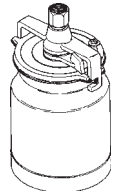

192218 Scrubs® Hand Cleaner Towels



Scrubs® are a premoistened hand cleaner towel for painters, body men and mechanics that go where you go and no water is needed.

WARRANTY

This product is covered by DeVilbiss' 1 Year Limited Warranty.

DeVilbiss Worldwide Sales and Service Listing: www.devilbiss.com

DeVilbiss Automotive Refinishing

DeVilbiss has authorized distributors throughout the world. For equipment, parts and service, check the Yellow Pages under "Automotive Body Shop Equipment and Supplies." For technical assistance, see listing below.

U.S./Canada Customer Service Office:

1724 Indian Wood Circle, Suite J-K, Maumee, OH 43537
 Toll-Free Telephone: 1-800-445-3988 (U.S.A. and Canada only)
 Toll-Free Fax: 1-800-445-6643

