



SERVICE BULLETIN SB-2-511-A

Replaces SB-2-511
Repair Kit SRI-426

SRI HIGH VOLUME LOW PRESSURE GRAVITY FEED SPOT REPAIR SPRAY GUN

IMPORTANT: Before using this equipment, read all safety precautions and instructions. Keep for future use.

DESCRIPTION

The SRI is a small gravity fed spray gun designed for spraying spot repairs and small areas. The gun can spray from a small round to a 9" fan pattern (according to setup). This product is suitable for use with both water-based and solvent-based coating materials.

SPECIFICATIONS

<i>Air Supply Connection:</i>	Universal 1/4" BSP and NPS (M)
<i>Maximum Static Air Inlet Pressure:</i>	$P_1 = 7$ bar (100 psi)
<i>Nominal Gun Air Inlet Pressure (with Gun Triggered):</i>	2 bar (29 psi)
<i>Gun Weight (with 4 oz. Cup and Lid):</i>	390g (13.76 oz.)

MATERIALS OF CONSTRUCTION FOR WETTED PARTS

<i>Gun Body:</i>	Anodized Aluminum
<i>Nozzle:</i>	303 Stainless Steel
<i>Needle:</i>	303 Stainless Steel
<i>Cups:</i>	Nylon and Aluminum
<i>Cup Lid:</i>	Polypropylene

This gun was manufactured to provide a maximum transfer efficiency by limiting air cap pressure to 10 psi (**complies with rules issued by SCAQMD and other air quality authorities**).

This gun will produce approximately 10 psi air cap pressure at 29 psi gun inlet pressure. An air cap test kit is available (see **Accessories**) which can be utilized to set the exact air cap pressure. Air consumption for the SRI is 5.0 SCFM at 10 psi cap pressure.

This gun comes with either an 8 oz. or 4 oz. aluminum gravity cup with a polypropylene lid plus a 4 oz. nylon disposable cup with a polypropylene lid.

NOTE

This gun includes 303 series stainless steel fluid tip and needle. This gun **should not** be used with chlorinated solvent materials. **See page 2 for potential hazards.**

Important: This gun may be used with most common coating and finishing materials. It is designed for use with mildly corrosive and non-abrasive materials. If used with other high corrosive or abrasive materials, it must be expected that frequent and thorough cleaning will be required and the necessity for replacement of parts will be increased.

INSTALLATION

For maximum transfer efficiency, **do not use more pressure than is necessary to atomize the material being applied.**

1. Connect the gun to a clean, moisture and oil free air supply. Fully open air flow valve (20). Install an air cap test kit over tip. When gun is triggered on, adjust regulated pressure to desired setting to provide a maximum of 10 psi at the air cap. **Do not use more pressure than is necessary to atomize the material being applied.** Excess pressure will create additional overspray and reduce transfer efficiency.

NOTE

If quick connects are required, use only high flow quick connects approved for HVLP use such as DeVilbiss HC-4419 and HC-4719. Other types will not flow enough air for proper gun operation.

NOTE

If an air adjusting valve is used at the gun inlet, use DeVilbiss Model HAV-500 or HAV-501. Some competitive adjusting valves have significant pressure drop that can adversely affect spray performance. Models HAV-500 and HAV-501 have minimal pressure drop, which is important for HVLP spraying.

NOTE

Protective coating and rust inhibitors have been used to keep the gun in good condition prior to shipment. Before using the gun, flush it with solvents so that these materials will be removed from fluid passages.

OPERATION

Mix, prepare and strain the material to be sprayed according to the paint manufacturer's instructions.

Strain material through a 60 or 90 mesh screen.

1. Fill the gravity feed cup with the material. Do not overfill. Make sure that the cup lid vent hole is clear.
2. Open the spreader adjustment valve (6) (Fan) by turning the valve stem counterclockwise.
3. Close the fluid needle adjusting screw (12) by turning clockwise.
4. Turn on air supply and set gun inlet pressure to lowest recommended pressure for material being sprayed. Best atomization will occur with 10 psig air cap pressure. However, some materials can be sprayed at lower pressures, improving transfer efficiency.
5. Spray a test area by turning fluid needle adjusting screw (12) counterclockwise until a full coat is obtained.

If the finish is too sandy and dry, the material flow may be too low for the atomization air pressure being used.

If the finish sags, there is too much material flowing for the atomization air pressure being used.

Both of the above can be corrected by increasing or decreasing the atomization air pressure or the material flow. Pattern width can be altered by turning spreader adjustment valve (6), either clockwise to decrease the width or counterclockwise to increase the width.

See Spray Gun Guide, SB-2-001 latest revision, for details concerning setup of spray guns.

2. Attach the gravity feed cup to the material inlet.

SAFETY PRECAUTIONS

This manual contains information that is important for you to know and understand. This information relates to USER SAFETY and PREVENTING EQUIPMENT PROBLEMS. To help you recognize this information, we use the following symbols. Please pay particular attention to these sections.



Important safety information - A hazard that may cause serious injury or loss of life.



Important information that tells how to prevent damage to equipment, or how to avoid a situation that may cause minor injury.

NOTE

Information that you should pay special attention to.



The following hazards may occur during the normal use of this equipment. Please read the following chart before using this equipment.





HAZARD	CAUSE	SAFEGUARDS
Fire 	Solvent and coatings can be highly flammable or combustible especially when sprayed.	Adequate exhaust must be provided to keep air free of accumulations of flammable vapors. Smoking must never be allowed in the spray area. Fire extinguishing equipment must be present in the spray area.
Solvent Spray 	During use and while cleaning and flushing, solvents can be forcefully expelled from fluid and air passages. Some solvents can cause eye injury.	Wear eye protection.
Inhaling Toxic Substances 	Certain materials may be harmful if inhaled, or if there is contact with the skin.	Follow the requirements of the Material Safety Data Sheet supplied by your coating material manufacturer. Adequate exhaust must be provided to keep the air free of accumulations of toxic materials. Use a mask or respirator whenever there is a chance of inhaling sprayed materials. The mask must be compatible with the material being sprayed and its concentration. Equipment must be as prescribed by an industrial hygienist or safety expert, and be NIOSH approved.
Explosion Hazard - Incompatible Materials 	Halogenated hydrocarbon solvents - for example; methylene chloride and 1,1,1, - Trichloroethane are not chemically compatible with the aluminum that might be used in many system components. The chemical reaction caused by these solvents reacting with aluminum can become violent and lead to an equipment explosion.	Due to the aluminum passageways in these guns, they must not be used with these solvents. Aluminum is also widely used in other spray application equipment – such as material pumps, regulators, valves and cups. Check all equipment items before use and make sure they can also be used safely with these solvents. Read the label or data sheet for the material you intend to spray. If in doubt as to whether or not a coating or cleaning material is compatible, contact your material supplier.
General Safety	Improper operation or maintenance of equipment.	Operators should be given adequate training in the safe use and maintenance of the equipment (in accordance with the requirements of NFPA-33, Chapter 15). Users must comply with all local and national codes of practice and insurance company requirements governing ventilation, fire precautions, operation, maintenance, and housekeeping. These are OSHA Sections 1910.94 and 1910.107 and NFPA-33.
Cumulative Trauma Disorders ("CTD's") CTD's, or musculoskeletal disorders, involve damage to the hands, wrists, elbows, shoulders, neck, and back. Carpal tunnel syndrome and tendonitis (such as tennis elbow or rotator cuff syndrome) are examples of CTD's.	Use of hand tools may cause cumulative trauma disorders ("CTD's"). CTD's, when using hand tools, tend to affect the upper extremities. Factors which may increase the risk of developing a CTD include: <ol style="list-style-type: none"> 1. High frequency of the activity. 2. Excessive force, such as gripping, pinching, or pressing with the hands and fingers. 3. Extreme or awkward finger, wrist, or arm positions. 4. Excessive duration of the activity. 5. Tool vibration. 6. Repeated pressure on a body part. 7. Working in cold temperatures. CTD's can also be caused by such activities as sewing, golf, tennis, and bowling, to name a few.	Pain, tingling, or numbness in the shoulder, forearm, wrist, hands, or fingers, especially during the night, may be early symptoms of a CTD. Do not ignore them. Should you experience any such symptoms, see a physician immediately. Other early symptoms may include vague discomfort in the hand, loss of manual dexterity, and nonspecific pain in the arm. Ignoring early symptoms and continued repetitive use of the arm, wrist, and hand can lead to serious disability. Risk is reduced by avoiding or lessening factors 1-7.

CHART 1

No. on Air Cap Order →	Air Cap with Ret. Ring (Ref. No. 1)	Fluid Needle Used With Fluid Tip →	Fluid Tip No.	Tip Size I.D.	
				in.	mm.
215	SRI-407-215	SRI-37	SRI-2-08-K*	.031	0.8
		SRI-3	SRI-2-10-K*	.039	1.0
		SRI-3	SRI-2-12-K*	.047	1.2

*Includes (1) SRI-6 fluid tip seal.

PREVENTIVE MAINTENANCE

To clean air cap and fluid tip, brush exterior with a stiff bristle brush. If necessary to clean cap holes, use a broom straw or toothpick if possible. If a wire or hard instrument is used, extreme care must be used to prevent scratching or burring of the holes which will cause a distorted spray pattern.

To clean fluid passages, remove excess material from cup, then flush with a suitable solvent. Wipe gun exterior with a solvent dampened cloth. Never completely immerse in solvent as this is detrimental to the lubricants and packings.

NOTE

When replacing the fluid tip or fluid needle, replace both at the same time. Using worn parts can cause fluid leakage. See Chart 1. It is recommended that the fluid tip seal (5) is replaced whenever the fluid tip is removed. Also, replace the needle packing at this time. Lightly lubricate the threads of the fluid tip before reassembling. Torque to 6-7 ft-lbs. Do not over-tighten the fluid tip.



To prevent damage to fluid tip (4) or fluid needle (10), be sure to either 1) pull the trigger and hold while tightening or loosening the fluid tip, or 2) remove fluid needle adjusting screw (12) to relieve spring pressure against needle collar.

SPRAY GUN LUBRICATION

Daily, apply a drop of SSL-10* spray gun lube at trigger bearing stud (19) and the stem of air valve (15) where it enters air valve assembly. The shank of fluid needle (10) where it enters packing nut (9) should also be oiled. Fluid needle packing (9) should be lubricated periodically. Make sure gun threads and retaining ring (2) threads are clean and free of foreign matter. Before assembling retaining ring to gun, clean the threads thoroughly, then add two drops of SSL-10 spray gun lube to threads. Fluid needle spring (11) and air valve spring (14) should be coated with a very light grease, making sure that any excess grease will not clog the air passages.

* Not for air tools or high RPM equipment.

For best results, lubricate the points indicated, daily.

- A. Trigger Points
- B. Packing
- C. Adjusting Knobs
- D. Gun Threads
- E. Air Valve Cartridge

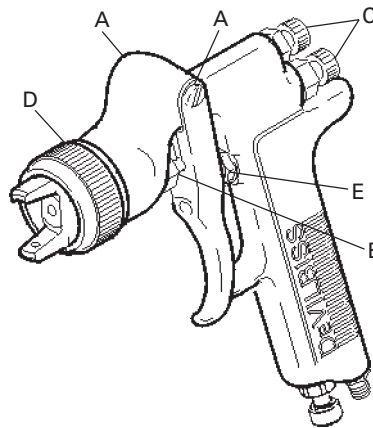

PARTS REPLACEMENT

SRI-411 Packing Replacement Instructions

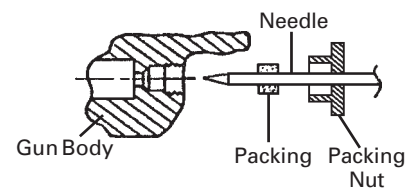

1. Remove adjusting knob and needle spring from gun.
2. Partially withdraw needle from gun body.
3. Loosen packing nut and remove.
4. Remove old packing.
5. Assemble packing nut to needle
6. Assemble packing in order shown to needle.
7. Insert needle all the way into gun body seating in tip.
8. Install needle spring and adjusting knob.
9. Thread packing nut into gun body.
10. Tighten packing nut in equal increments - no more than 1/6 turn at a time.
11. After each adjustment, pull needle open and observe needle closure.
12. If needle snaps shut, continue adjusting nut until there is evidence of needle bind or slow closing.
13. Back off packing nut 1/12 turn or less to the point where needle snaps shut. Packing nut must remain tight enough to prevent loosening by hand.
14. Pull needle several times to verify needle snaps shut and check packing nut for looseness.

Views showing correct
Air Cap/Retaining Ring assembly.

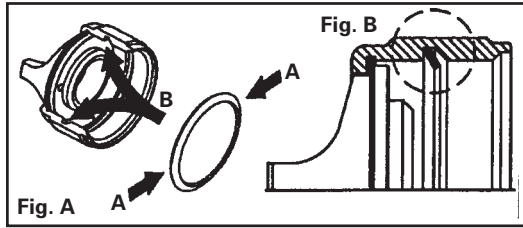

Patent Pending

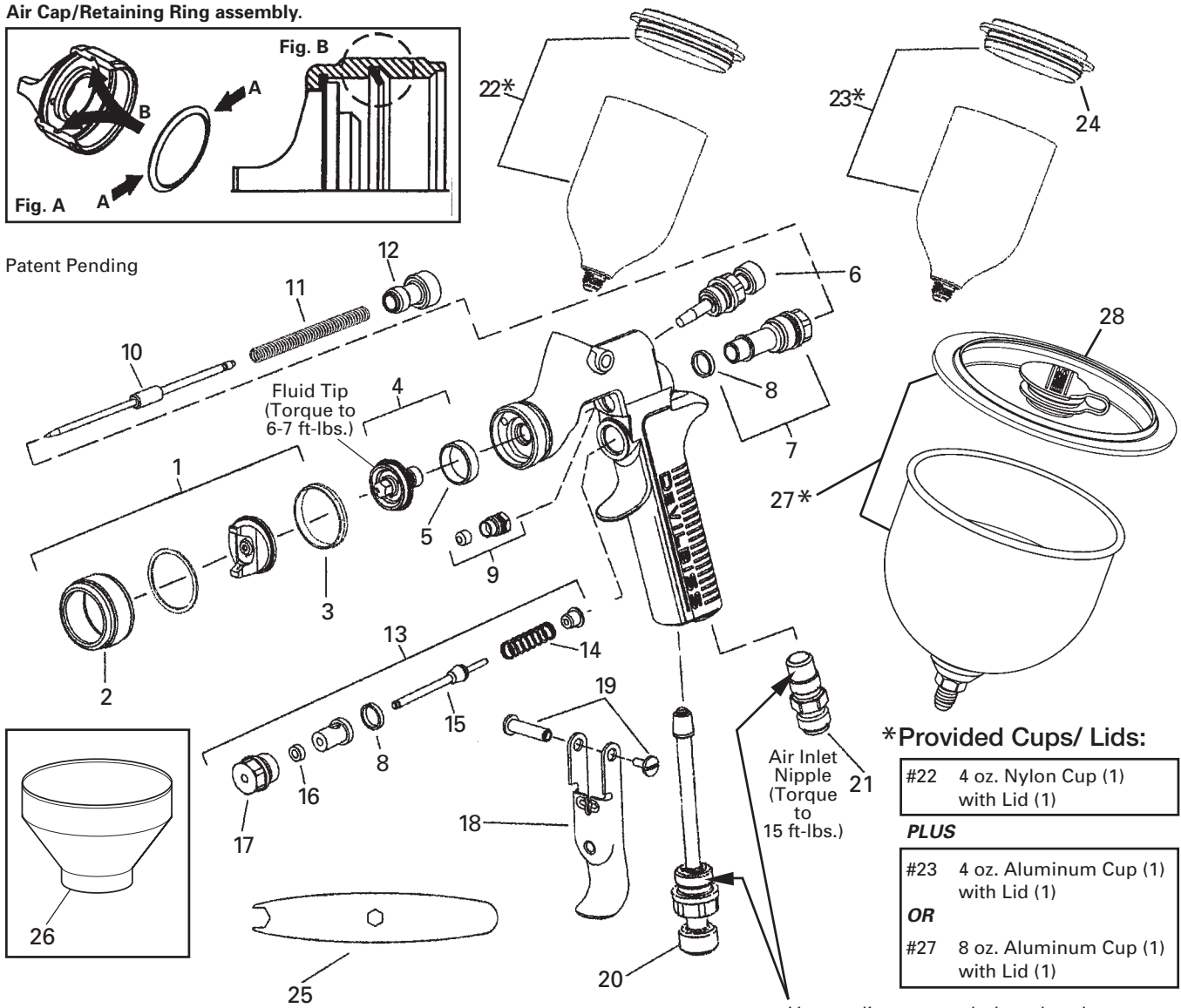

Use medium strength thread sealant (i.e. Devcon #2242 Blue, or equal) on threads





PARTS LIST

Ref. No.	Replacement Part No.	Description	Ind. Parts Req.
1	See Chart 1	Air Cap/Retaining Ring-HVLP	1
2	—	Retaining Ring	1
●3	SRI-35-K5	Air Cap Seal Kit (5)	1
4	See Chart 1	Fluid Tip & Seal Kit	1
●5	SRI-6-K5	Fluid Tip Seal Kit (5)	1
6	SRI-415	Spreader Valve Assy.	1
7	SRI-17-K	Body Bushing Kit	1
●8	—	Seal	2
●9	SRI-411-K3	Needle Packing Kit (3 Packings & 1 Nut)	1
10	See Chart 1	Fluid Needle	1
●11	—	Needle Spring	1
12	SRI-19-K2	Needle Adjusting Knob Kit (2)	1
13	SRI-404-K	Air Valve Assembly	1
●14	—	Air Valve Spring	1
15	—	Air Valve Stem Assembly	1
●16	—	Air Valve Seal	1
17	—	Air Valve Body	1

Ref. No.	Replacement Part No.	Description	Ind. Parts Req.
18	SRI-9	Trigger (SRI)	1
19	SRI-412	Trigger Stud & Screw Kit	1
20	SRI-402	Air Control Valve	1
21	SRI-40	Air Inlet Adaptor	1
22	SRI-478-K12	Cup & Lid Kit (Nylon Cup) 4 ea. color (12)	1
23	54-4458	Cup & Lid Kit (4 oz. Aluminum Cup) (Kit of 1 ea. Cup & Lid)	1
24	54-4539	Lid Kit (Kit of 3 for 4 oz. Aluminum Cup)	1
●25	—	Wrench SRI	1
26	SRI-51-K12	Funnel Kit (12)	1
27	81-381	Cup & Lid Kit (8 oz. Aluminum Cup) (Kit of 1 ea. Cup & Lid)	1
28	54-4251	Lid Kit (Kit of 3 for 8 oz. Aluminum Cup)	1

● SRI-426 Gun Repair Kit includes a quantity of necessary parts.







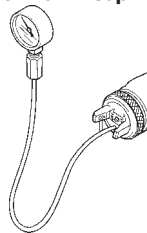

TROUBLESHOOTING

CONDITION	CAUSE	CORRECTION
Heavy top or bottom pattern 	Horn holes plugged. Obstruction on top or bottom of fluid tip. Cap and/or tip seat dirty.	Clean. Ream with non-metallic point. Clean. Clean.
Heavy right or left side pattern 	Left or right side horn holes plugged. Dirt on left or right side of fluid tip. Remedies for the top-heavy, bottom-heavy, right-heavy, and left-heavy patterns: 1. Determine if the obstruction is on the air cap or the fluid tip. Do this by making a test spray pattern. Then, rotate the cap one-half turn and spray another pattern. If the defect is inverted, obstruction is on the air cap. Clean the air cap as previously instructed. 2. If the defect is not inverted, it is on the fluid tip. Check for a fine burr on the edge of the fluid tip. Remove with #600 wet or dry sand paper. 3. Check for dried paint just inside the opening; remove by washing with solvent.	Clean. Ream with non-metallic point. Clean.
Heavy center pattern 	Fluid flow too high for atomization air. Material flow exceeds air cap's capacity. Spreader adjustment valve set too low. Atomizing pressure too low. Material too thick.	Balance air pressure and fluid flow. Increase spray pattern width with spreader adjustment valve. Thin or lower fluid flow. Adjust. Increase pressure. Thin to proper consistency.
Split spray pattern 	Atomization air pressure too high. Fluid flow too low. Spreader adjusting valve set too high.	Reduce at transformer or gun. Increase fluid flow (increases gun handling speed). Adjust.
Jerky or fluttering spray 	*Loose or damaged fluid tip/seat. Baffle seal installed incorrectly. Material level too low. Container tipped too far. Obstruction in fluid passage. Dry or loose fluid needle packing nut.	Tighten or replace. Install per directions. Refill. Hold more upright. Backflush with solvent. Lubricate or tighten.
Unable to get round spray	Spreader adjustment screw not seating properly. Air cap retaining ring loose.	Clean or replace. Tighten.
Will not spray	No air pressure at gun. Fluid needle adjusting screw not open enough. Fluid too heavy for gravity feed.	Check air supply and air lines, blow out gun air passages. Open fluid needle adjusting screw. Thin material and/or change to larger tip size.
Paint bubbles in cup	Fluid tip not tight.	Tighten tip to 6-7 ft-lbs.
Fluid leaking or dripping from cup lid	Cup lid loose. Cracked cup or lid.	Push in or tighten lid. Replace cup and lid.
Starved spray pattern	Inadequate material flow. Low atomization air pressure.	Back fluid adjusting screw out to first thread, or change to larger tip size. Increase air pressure and rebalance gun.
Excessive overspray	Too much atomization air pressure. Gun too far from work surface. Improper stroking (arcing, gun motion too fast).	Reduce pressure. Adjust to proper distance. Move at moderate pace, parallel to work surface.
Excessive fog	Too much or too fast-drying thinner. Too much atomization air pressure.	Remix properly. Reduce pressure.
Dry spray	Air pressure too high. Gun tip too far from work surface. Gun motion too fast. Gun out of adjustment.	Reduce air pressure. Adjust to proper distance. Slow down. Adjust.
Fluid leaking from packing nut	Packing nut loose. Packing worn or dry.	Tighten, do not bind needle. Replace or lubricate.
Fluid leaking or dripping from front of gun	Packing nut too tight. Dry packing. Fluid tip or needle worn or damaged. Foreign matter in tip. Fluid needle spring broken. Wrong size needle or tip.	Adjust. Lubricate. Replace tip and needle. Clean. Replace. Replace.

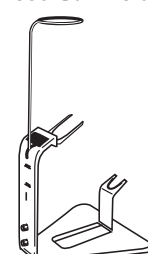
*Most common problem.

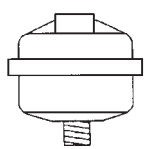
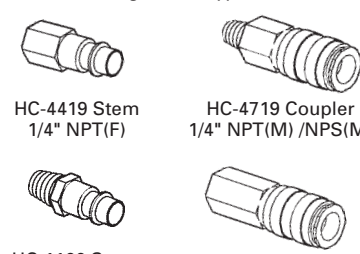
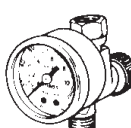
CONDITION	CAUSE	CORRECTION
Fluid dripping or leaking from bottom of cup	Cup loose on gun. Cup threads dirty.	Tighten. Clean
Runs and sags	Too much material flow. Material too thin. Gun tilted on an angle, or gun motion too slow.	Adjust gun or reduce fluid flow. Mix properly or apply light coats. Hold gun at right angle to work and adapt to proper gun technique.
Thin, sandy coarse finish drying before it flows out	Gun too far from surface. Too much air pressure. Improper thinner being used.	Check distance. Normally approx. 3-6". Reduce air pressure and check spray pattern. Follow paint manufacturer's mixing instrs.
Thick, dimpled finish "orange peel"	Gun too close to surface. Air pressure too low. Improper thinner being used. Material not properly mixed. Surface rough, oily, dirty.	Check distance. Normally approx. 3-6". Too much material coarsely atomized. Increase air pressure or reduce fluid flow. Follow paint manufacturer's mixing instrs. Properly clean and prepare.

ACCESSORIES

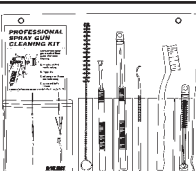
<p>SRI-5033-215 Air Cap Test Kit</p>  <p>The purpose of this test kit is to measure air cap pressures. Used to confirm code compliance and as a daily quality control measure.</p>	<p>MSP-524 Twin Cartridge, Paint Spray</p>  <p>NIOSH-Certified (TC84A-1623) for respiratory protection in atmospheres not immediately dangerous to life.</p>	<p>54-4350 Gun Holder</p>  <p>Designed to hold gravity feed guns and cups. Also holds paint strainers.</p>	<p>KK-5060 Air Cap Cleaning Kit</p>  <p>Consists of: 2 brushes, 1 wire pick. Helps keep air cap clean and performing properly.</p>	<p>HAF-507 Whirlwind™ In-Line Air Filter</p>  <p>Removes water, oil, and debris from the air line.</p>
<p>Automotive Refinish Quick Connects For HVLP Guns (Air) High Flow Type.</p>  <p>HC-4419 Stem 1/4" NPT(F) HC-4719 Coupler 1/4" NPT(M) /NPS(M) HC-1166 Stem 1/4" NPT(M) HC-4720 Coupler 1/4" NPT(F)</p>	<p>HAV-500 OR HAV-501 Adjusting Valve (HAV-501 SHOWN)</p>  <p>HAV-500 does not have pressure gauge. Use to control air usage at gun.</p>	<p>192218 Scrubs® Hand Cleaner Towels</p>  <p>Scrubs® are a premoistened hand cleaner towel for painters, body men and mechanics that go where you go and no water is needed.</p>	<p>Spray Gun Lube SSL-10 (2 oz. bottle)</p>  <p>Compatible with all paint materials; contains no silicone or petroleum distillates to contaminate paint. MSDS Sheet available upon request.</p>	
<p>192219 Gun Holder, Coated</p> 	<p>192212 Professional Spray Gun Cleaning Kit</p>  <p>Contains six precision tools designed to effectively clean all DeVilbiss, Binks, Finishline and other brand products.</p>			

WARRANTY

This product is covered by DeVilbiss' 1 Year Limited Warranty.

DeVilbiss Worldwide Sales and Service Listing: www.devilbiss.com

DeVilbiss Automotive Refinishing

DeVilbiss has authorized distributors throughout the world. For equipment, parts and service, check the Yellow Pages under "Automotive Body Shop Equipment and Supplies." For technical assistance, see listing at right.

U.S./Canada Customer Service Office:

1724 Indian Wood Circle, Suite J-K, Maumee, OH 43537
Toll-Free Telephone: 1-800-445-3988 (U.S.A. and Canada only)
Toll-Free Fax: 1-800-445-6643

