

# HVLP SPRAY GUNS

## Model JGHV-520

**IMPORTANT:** Before using this equipment, read **SAFETY PRECAUTIONS** starting on page 2.

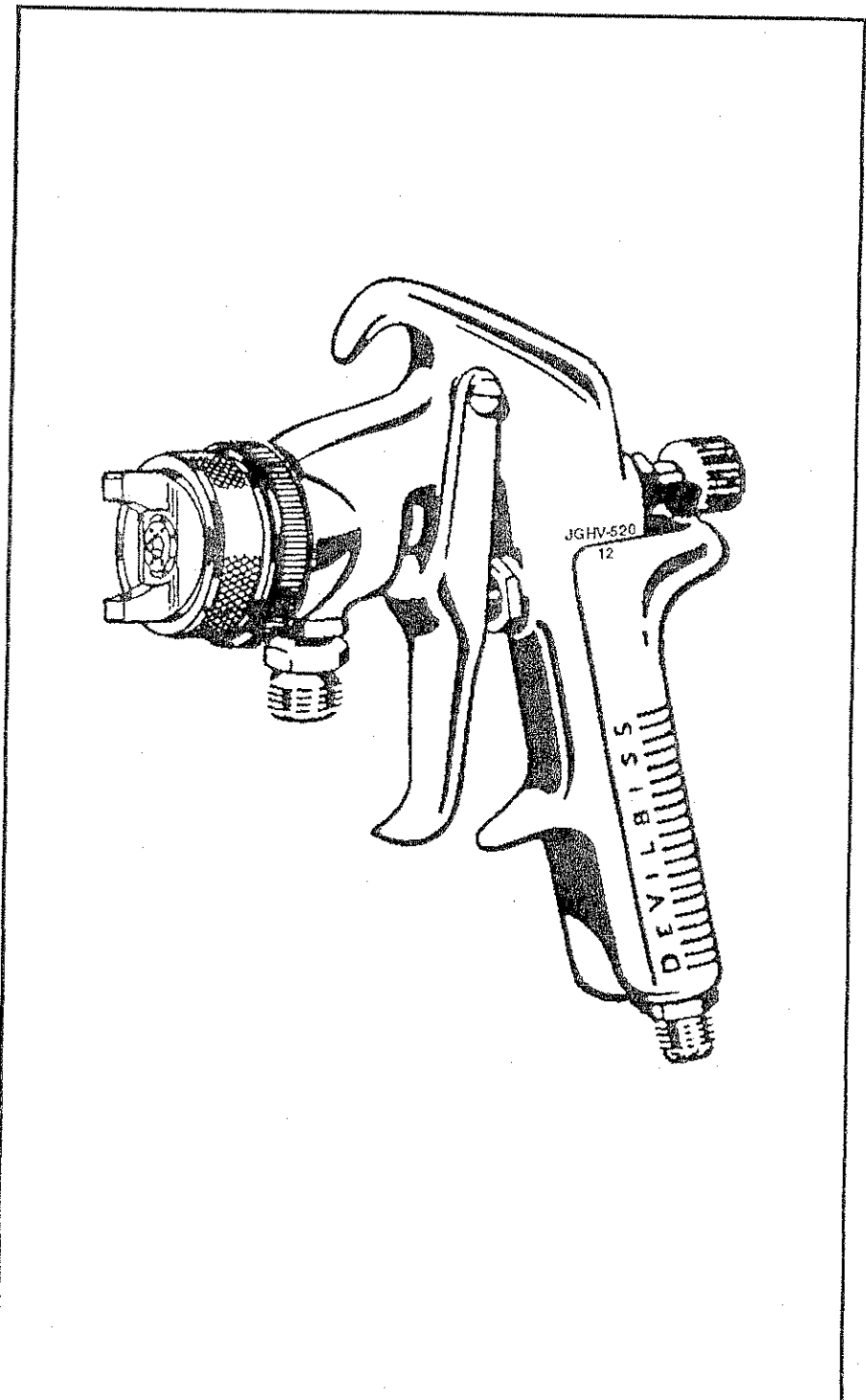

## SAFETY PRECAUTIONS

This manual contains important information that ALL users should know and understand BEFORE using the equipment. This information relates to USER SAFETY and PREVENTING EQUIPMENT PROBLEMS. To help you recognize this information, we use the following terms to draw your attention to certain equipment labels and portions of this manual. Pay special attention to any label or information that is highlighted by one of these terms:

### WARNING

Important information to alert you to a situation that might cause serious injury if instructions are not followed.

### CAUTION



Important information that tells how to prevent damage to equipment, or how to avoid a situation that might cause minor injury.

### Note

Information that you should pay special attention to.

### WARNING

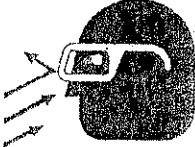
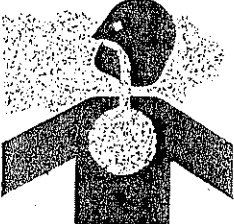
The following hazards may occur during the normal use of this equipment. Please read the following chart.

AREA Tells where hazards may occur.	HAZARD Tells what the hazard is.	SAFEGUARDS Tells how to avoid the hazard.
<b>Spray Area-Fire Hazard</b> 	Solvents and coatings can be highly flammable or combustible, especially when sprayed.	Adequate exhaust must be provided to keep the air free of accumulations of flammable vapors.  Smoking must never be allowed in spray area.  Fire extinguishing equipment must be present in the spray area.
<b>Toxic Substances</b> 	During cleaning and flushing, solvents can be forcefully expelled from fluid and air passages. Some solvents can cause eye injury or irritation.	Wear eye protection.
<b>Toxic Substances</b> 	Certain materials may be harmful if inhaled, or if there is contact with the skin.	Follow the requirements of the Material Safety Data Sheet supplied by coating material manufacturer.  Adequate exhaust must be provided to keep the air free of accumulations of toxic materials.  Use a mask or respirator whenever there is a chance of inhaling sprayed materials. The mask must be compatible with the material being sprayed and its concentration. Equipment must be as prescribed by an industrial hygienist or safety expert, and be NIOSH approved.
<b>Explosion Hazard-Incompatible Materials</b> 	Halogenated hydrocarbon solvents-for example: methylene chloride and 1,1,1-Trichloroethane are not chemically compatible with the aluminum that might be used in many system components. The chemical reaction caused by these solvents reacting with aluminum can become violent and lead to an equipment explosion.	The JGHV spray gun itself can be used with these solvents. However, aluminum is widely used in other spray application equipment — such as material pumps, cups, regulators, valves, etc. Check all other equipment items before use and make sure they can also be used safely with these solvents. Read the label or data sheet for the material you intend to spray. If in doubt as to whether or not a coating or cleaning material is compatible contact your material supplier. Any other type of solvent may be used with aluminium equipment.
<b>General Use Maintenance</b>	Improper operation or maintenance may create a hazard.	Personnel must be given training in accordance with the requirements of NFPA-33, Chapter 15.  Instructions and safety precautions must be read and understood prior to using this equipment.  Comply with appropriate local, state, and national codes governing ventilation, fire protection, operation maintenance, and housekeeping. OSHA references are Sections 1910.94 and 1910.107. Also refer to NFPA-33 and your insurance company requirements.

**DESCRIPTION**

The JGHV-520 is a high volume, low pressure (HVLP) manual spray gun designed to be in compliance with rules issued by South Coast Air Quality Management District (SCAQMD) and other air quality authorities who define HVLP as a spray process using air at between 0.1 and 10 psi, when it is supplied with compressed air at the gun inlet using a maximum pressure of 80 psi or less. Actual atomizing pressure may be lower than shown in Chart 3, Pg. 6, as a result of normal manufacturing tolerances.

**Note**

Gun designation is identified as either JGHV-520-14-15 or JGHV-520-12-16. This is stamped on the left side of the spray gun. There should be no attempt to interchange fluid tip and air caps between the guns. This will cause a significant change to air pressure as measured at the air cap and could influence spray gun compliance or performance or both.

Paint material should be pressure fed to the gun using either an attached TLC-575 HVLP cup or suitable pressure tank or material pump.

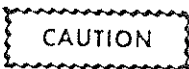

The guns are not designed for use with highly corrosive or highly abrasive materials. If such materials are used, the need for cleaning, maintenance and parts replacement will be greatly increased.

**MODELS & SPECIFICATIONS**

Models Available:

JGHV-520-12GX

JGHV-520-14FY

JGHV-520-16FF

JGHV-520-16DE

**Note**

Input air pressure to all JGHV spray guns should be adjusted to 80 psi measured at the output air regulator. This adjustment will provide a maximum spray gun output pressure of 10.5 psi measured at the cup port and 10 psi measured at the air cap.

See Chart 1 on pg 6 for further explanation.

Ordering Example:

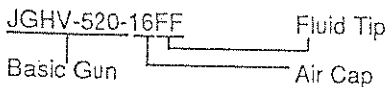

Standard features include high grade stainless steel material passages and needles to resist corrosion. An optional Delrin tipped (See Chart 1) needle design is also available.

Connections	
Air	1/4" NPS
Material	3/8" NPS
Weight	25 oz (708g)

**INSTALLATION**

**Note**

Coatings and rust inhibitors have been used to protect the gun during shipping. Flush the spray gun with a suitable solvent before use.

1. For consistent results and a high quality finish, an air transformer should be installed as close as possible to the gun to provide clean regulated air.
2. Connect air supply hose (at least 5/16" ID) to air inlet (25).
3. Connect material hose, or TLC-575 cup, to material inlet (15).

**Note**

If TLC-575 Cup is used, KR-103 (26) is required to provide cup pressure.

**OPERATION**

**Note**

See Chart 3, Pg. 6, for input pressure adjustment. To monitor input pressure, install HAV-501 (see Accessories") at the gun handle and adjust pressure to range desired for cap output. Atomization air should be adjusted to the level required to obtain satisfactory breakup. Maximum inlet pressure is 80 psi (5.4 bars).

1. Mix, prepare and strain the material to be sprayed according to the paint manufacturer's instructions.

Use a lint free mesh to strain the material.

**Note**

Important: Before using gun, tighten packing not until the needle starts to bind. Then loosen nut just enough so the needle moves freely.

2. Turn needle adjusting screw (14) counterclockwise. Pull trigger (16) and turn screw (14) clockwise until resistance is felt. This ensures maximum needle travel to minimize wear on the fluid tip (3) and needle (10).
3. Turn fan pattern adjustment ring (6) to fully open position by turning clockwise, as viewed from back of gun.
4. Fill tank or cup and turn material pressure down to lowest pressure and turn on.
5. Turn on air at transformer.
6. Adjust spray pattern as follows: Start with lowest possible regulated material pressure and test spray. Increase material pressure until a full wet coat is achieved.

The pattern width can be altered by rotating ring (6) fully counterclockwise for round spray or clockwise for fan spray. It is recommended for the best results that the fluid tip selected avoids excessively high flow rates at low fluid pressures. See Chart 2, pg 6.

The gun should be held perpendicular to the spray surface at all times. Arcing the gun will cause an uneven coat of paint. The recommended spraying distance is between 6" and 8" (150-200mm). See example on pg 4.

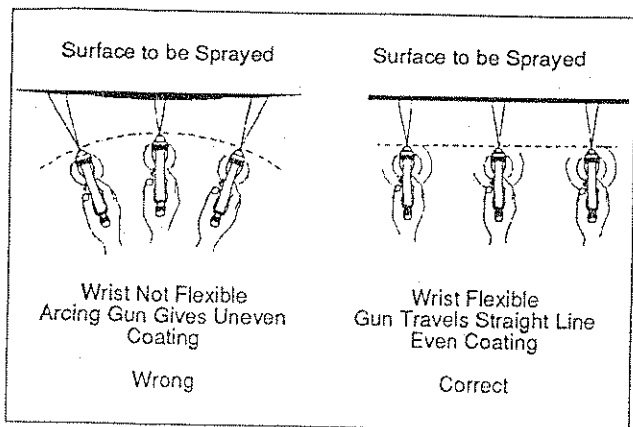

## PREVENTIVE MAINTENANCE

### WARNING

**Risk of Injury. Equipment and fluid may be under pressure. All pressure in the system must be relieved before beginning the cleaning procedure and before replacing any parts.**

### Cleaning

### CAUTION

Never soak the spray gun in solvents. The lubricants and packings will be damaged and the performance and life expectancy of the gun reduced. Wipe off the exterior of the gun with a solvent dampened rag.

1. Turn off air supply to pump, pressure cup or tank and gun.
2. Relieve pressure by pulling trigger on gun. Most pressure cups and tanks have a valve to relieve pressure.
3. Material in hoses may be drained back to pressure cup and tank by loosening the lids, keeping the gun higher than the cup or tank and pulling the trigger. Pour off remaining material.

A hose cleaner may be used to clean inside of hose and gun. If a hose cleaner is not available or if using a pump, remove remaining material, set-up pump, tank or cup with a compatible solvent. Ensure the atomizing air is off and trigger the gun into a waste container.

Wipe the exterior of the gun with a solvent dampened rag. Clean the air cap by immersing in solvent. If the orifice is clogged, use a broom straw or toothpick to remove the obstruction.

## PARTS REPLACEMENT

### Fluid Tip (3), Baffle (5) and/or Fan Ring (6)

1. Remove screw (14) and spring (11) to ensure that the valve seats are not damaged.
2. Unscrew retaining ring (1) and remove air cap (2).
3. Use wrench, SPN-6, or a 6 point, 10mm socket wrench to unscrew fluid tip (3). Remove gasket (4),

baffle (5) and fan ring (6) complete with spring rings (7). Replace any worn or damaged parts.

4. Re-assemble reversing steps 1 to 3. Torque Fluid Tip (3) to 24.4 - 27.1 Nm (216 - 240 in. lbs.).

### Note

Always replace gasket (4) when fluid tip is removed or replaced.

### Spring Rings (7)

Repeat steps 1 to 3.

5. Remove spring rings (7) from fan ring (6) using pliers.
6. Coat spring rings with petroleum jelly before replacing. Fit spring rings with coils in opposite directions, one clockwise and the other counter-clockwise. Align the tangs, ensuring that the spring rings are not crossed in the groove in the fan ring (6).
7. Replace fan ring (6) onto the gun body with spring tangs engaged in the body location slot. Hold in place and rotate ring (6) until baffle pin hole is visible through the longest slot in the fan ring.

Re-assemble, reversing steps 1 to 4.

### CAUTION

Ensure that the tangs of both spring rings (7) are properly located in the gun body slot and baffle pin (5) is engaged in the hole in the gun body, before tightening fluid tip (3).

### Fluid Needle (10) and Packing (8)

8. Remove adjusting screw (14).
9. Withdraw spring (11) and needle (10).
10. Remove trigger (16) by unscrewing trigger bearing stud (17) from screw (18).
11. Unscrew packing nut (9) and remove packing (8). The packing should be replaced when a new needle is fitted.

A few drops of gun lube, SSL-10, should be applied to the packing before assembly.

Re-assemble reversing steps 8 to 11. Ensure that needle seats correctly in the fluid tip and that the movement of the needle is not restricted.

### 'U' Cup (22) or Spring (24)

Repeat Step 10.

12. Unscrew air valve cage and withdraw assembly (19).
13. Remove snap ring (20), washer (21) and cup (22).

Replace any worn or damaged parts. Re-assemble reversing steps 10 to 13.

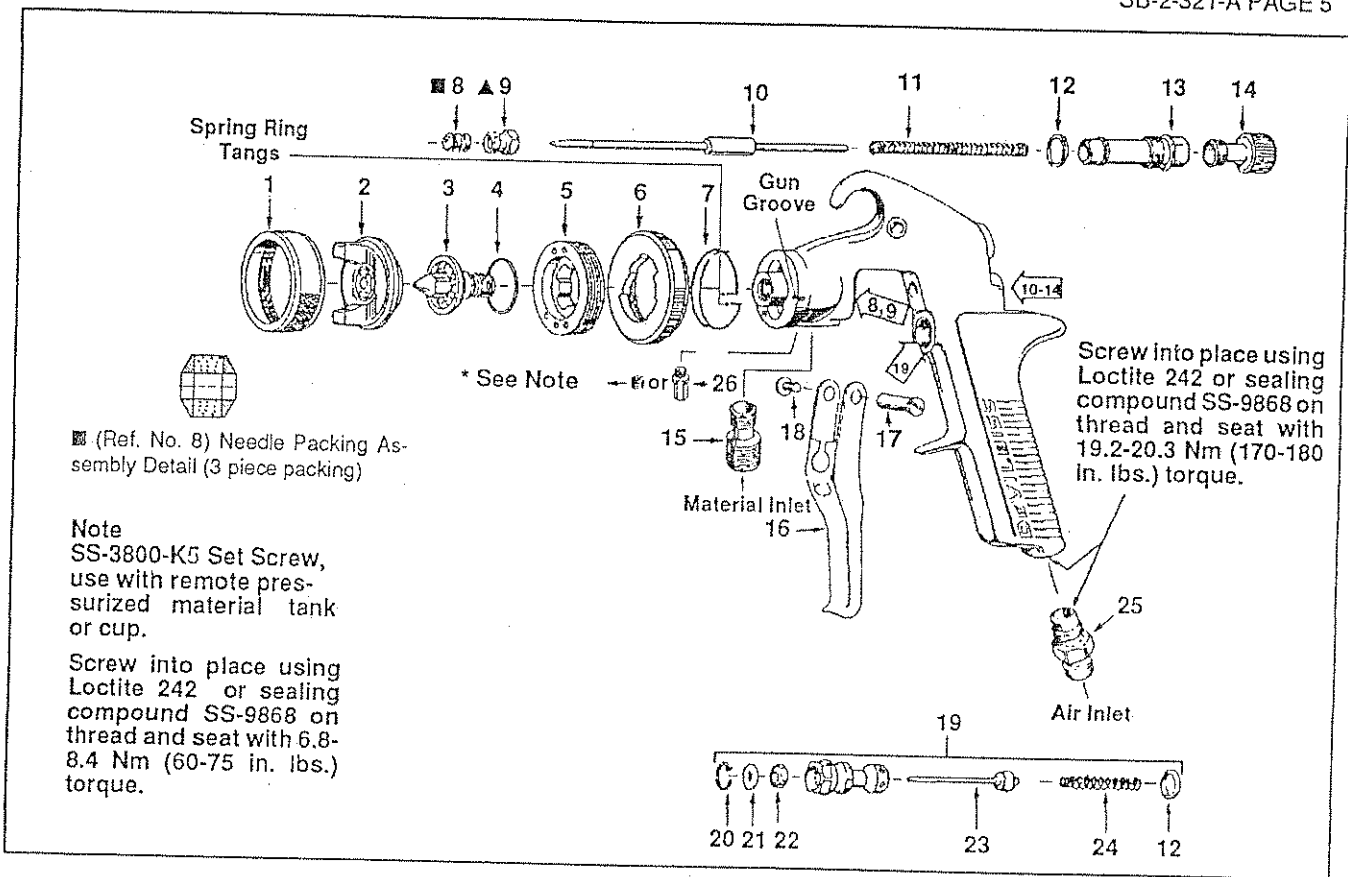

Figure 2 Exploded View

Ref. No.	Replacement Part No.	Description	Qty.
1	JGHV-3	Retaining Ring	1
2	See Chart 1	Air Cap	1
3	See Chart 1	Fluid Tip	1
*4	AV-1-K5	Gasket	1
5	JGHV-407	Baffle	1
6	JGHV--5	Fan Adjustment Ring	1
7	JGHV-19-K4	Spring ring	2
*8	JGA-4035-K3	Packing Set	1
▲9	34411-122-K3	Packing Nut	1
10	See Chart 1	Fluid Needle	1
*11	MBD-19-K5	Spring	1
*12	JGS-72-K10	Gasket	2
13	JGA-17	Gun Body Bushing	1
14	JGS-16	Fluid Needle Adjusting Screw	1
15	JGHV-8	Fluid Connector	1
16	JGS-108	Trigger	1
*17	JGS-35-K5	Stud	1
*18	A-42-K5	Screw	1
19	JGS-449	Air Valve Assy.	1
20	JGA-14-K5	Snap Ring	1
21	JGA-15-K5	Washer	1
*22	JGS-26-K5	'U' Cup	1
*23	JGS-431	Air Valve	1
*24	MBD-12-K5	Spring	1
25	P-MB-51	Connector 1/4 NPS	1
26	{ KR-103-K4 SS-3800-K5	Air Adapter (See Note) Set Screw (See Note)	1

Suffixes -K4, -K6 designates Kits of multiple parts. Example: AV-1-K5 is a kit of (5) gaskets.

\*A quantity of necessary parts is included in Repair Kit KK-4911.  
▲ Important: Before using gun, tighten packing nut until the needle starts to bind. Then, loosen nut just enough so the needle moves freely.

*See next 2 pgs for new air cap 142 & 162*

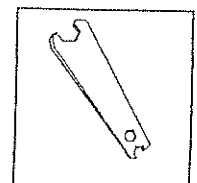

Figure 3 SPN-6 Wrench

ACCESSORIES

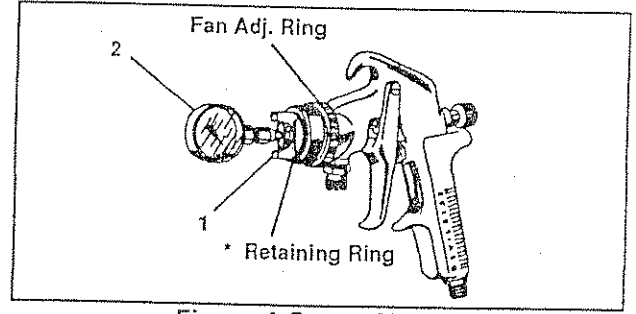

Figure 4 Gauge Tester

KK-4960 - Use on Models with - 12 air cap  
KK-4961 - Use on Models with - 14 air cap  
KK-4962 - Use on Models with - 16 air cap

Ref. No.	Replacement Part No.	Description	Qty.
1	JGHV-429-12	Air Cap (12) with Fitting	1
	JGHV-429-14	Air Cap (14) with Fitting	1
	JGHV-429-16	Air Cap (16) with Fitting	1
2	GA-313	Gauge (0-15 psi)	1

\*Customer must use retaining ring from existing gun.

The purpose of this test kit is to measure air cap atomizing air pressure at the air cap to demonstrate compliance to air quality regulations.

Chart 1 Air Cap (2), Fluid Tip (3), Needle (10) Combinations

Gun Model	No. on Cap	Fluid Tip in	Size		Ordering Number		
			mm	Ref (2)	†Ref (3)	Ref (10)	Ref (10)
JGHV-520-12GX	12	GX .034	0.9	JGHV-16-12	JGHV-601-GX	JGHV-425-GX	JGHV-412-GX
JGHV-520-14FY	14	FY .039	1.0	JGHV-16-14	JGHV-601-FY	JGHV-425-FY	JGHV-412-GX
JGHV-520-16FF	16	FF .055	1.4	JGHV-16-16	JGHV-601-FF	JGHV-425-FF	JGHV-412-FF
JGHV-520-16DE		DE .079	2.0		JGHV-601-DE	JGHV-425-DE	JGHV-412-DE

† Includes AV-1 gasket (4).

Chart 2 Recommended Fluid Flow Rates

Fluid Tip Size	Fluid Flow oz/min	Pattern Size	Materials
GX (.034)	4-8	6-8"	Low to Medium Viscosity
FY (.039)	8-12	8-10"	Medium Viscosity
FF (.055)	12-14	12-14"	Medium Viscosity
DE (.079)	12-16	12-14"	Medium to Higher Viscosity

*Base Clear*

Chart 3 Atomizing Air Pressure

The table below shows the maximum atomizing air pressure obtainable with the JGHV-520 at various inlet pressures.

Inlet Air Pressure (psi)	Maximum Atomizing Air Pressure (psi)
10	0.6
20	1.5
30	2.5
40	3.7
50	5.0
60	6.5
70	8.2
80	10.0

TROUBLESHOOTING



A Normal Spray Pattern - Proper gun adjustment will result in normal spray patterns, from round with the fan control valve (9) closed, to long and narrow with the valve open. Pattern width depends upon how much the valve is opened, the type of air cap used, and fluid output rate.



NORMAL SPRAY PATTERN

The normal combination of fluid pressure, air assist pressure, and fluid tip should result in a normal pattern of this shape.

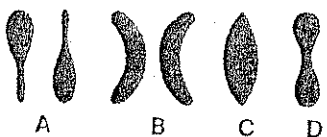
TROUBLESHOOTING CHART

PROBLEM	CAUSE	CORRECTION
Will not spray.	No pressure to gun. Fluid adjusting screw (14) not properly adjusted.	Check air and material lines. Correct. (See "Operation")
Improper spray pattern 	A. Gun not adjusted properly. A, B. Material build up on the air cap or fluid tip. C, D. Wrong material or material too thick.	A. Re-adjust. See "Operation". A, B. Clean the air cap or fluid tip. See "Preventive Maintenance". C, D. Adjust material pressure or thin material.
Jerky or fluttering spray 	Insufficient material in the pressure cup or tank or an obstruction in the line. Gun material passage plugged. Worn packing (8) or loose packing nut (9). Loose or damaged fluid tip (3). Loose pressure cup fitting.	Fill or clear obstruction. Clean. Replace or tighten. Tighten or replace. Tighten fitting.
Fluid leaking from packing nut (9).	Packing nut (9) loose. Packing (8) dry or worn.	Tighten. Check needle for free movement. Replace or lubricate.
Dripping from fluid tip (3).	Dry packing (8). Sluggish needle (10) or needle (14). Tight packing nut (9). Fluid tip (3) worn.	See "Lubrication". See "Lubrication". Adjust. Replace.
Air leakage backwards around fan ring (6).	Loose fluid tip (3). Flattened tip gasket (4).	Tighten fluid tip to proper torque. Replace gasket.

**ACCESSORIES**

**SPRAY GUN LUBE**  
SSL-10 (2 oz. bottle)



Compatible with all paint materials: contains no silicone or petroleum distillates to contaminate paint.

**HAV-501**

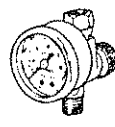

Use to control and adjust air usage at gun.

**HD-501**  
HOSE CLEANER

WARNING

Risk of injury or damage. Do not use with halogenated hydrocarbon solvents.

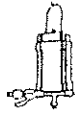

Hose cleaner used to clean the inside of hose and material passages of gun.

**TLC-575**  
PRESSURE FEED CUP

WARNING

Risk of injury or damage. Do not use with halogenated hydrocarbon solvents.

Capacity 1 Qt.  
Maximum Air Pressure 10psi  
Thread Size 3/8" NPS (F)

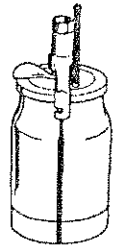

**SERVICE BULLETIN REVISIONS**

Refer to the following chart for Part No./ Literature Changes.

Part Number Changes			Literature Changes
Old Part Number	New Part Number	Interchangeability	
	JGHV-425-GX S/S Needle	Directly	1. Revised Worldwide Sales & Service Listing.
	JGHV-425-FY S/S Needle	Directly	
	JGHV-425-FF S/S Needle	Directly	
	JGHV-425-DE S/S Needle	Directly	

**WARRANTY**

This product is covered by DeVilbiss' 1 Year Limited Warranty. See SB-1-000 which is available upon request.

**WORLDWIDE SALES AND SERVICE**

DeVilbiss has authorized distributors throughout the world. For equipment, parts and service, check the yellow pages under "Spray Equipment" or "Compressors." If further assistance is required, write or call one of the following DeVilbiss Distribution Centers or Sales Offices nearest you.

**FOR LOCAL ORDER ENTRY AND CUSTOMER SERVICE, CALL TOLL FREE 1-800-338-4448 (U.S. ONLY). FOR LOCAL CALLS, SEE LISTING BELOW.**

U.S. Sales and Distribution Centers	Address	Telephone No.
ATLANTA, GA 30336	520 Wharton Circle, P.O. Box 43226 Industrial Branch	(404) 696-4988 Toll Free Fax No. 1-800-888-1109
SANTA FE SPRINGS, CA 90670	12878 E. Florence Avenue	(213) 944-1111 Toll Free Fax No. 1-800-733-2256
WALBRIDGE (Toledo), OH 43465-9798	6722 Commodore Street	(419) 661-5200 Toll Free Fax No. 1-800-338-0131

\* Sales Office Only:

* DARIEN (Chicago), IL 60559	8205 South Cass Ave. Suite 102	(708) 969-0440 Fax No. 708-969-1397
* KING OF PRUSSIA, PA 19406	1150 First Ave., Suite 792	(215) 768-0870 Fax No. 215-768-5887

Canada Sales and Distribution Centers	Address	Telephone No.
Barrie, Ontario, L4M 4V6	50 Wood St., P.O. Box 3000	(705) 728-5501 Fax No. 705-726-9866

\* Sales Office Only:

* Woodbridge, Ontario L4L 8G4	1 Whitmore Rd. Bldg. A, Unit 21	(416) 856-7284 Fax No. 416-856-7369
* St. Leonard, Montreal, Quebec H1R 3H7	4815 Couture Blvd.	(514) 326-9640 Fax No. 514-322-7755
* Burnaby, B.C. V5C 4T3	5 - 1680 Gilmore Ave.	(604) 294-3787 Fax No. 604-294-2336

**INTERNATIONAL MARKETING AND MANUFACTURING**

- |   |  |
|---|--|
| The DeVilbiss Co., Ltd., Bournemouth, England         | * DeVilbiss (Australasia) Pty. Ltd., Moorabbin, Vic. Australia |
| DeVilbiss S.A., Sao Paulo, Brasil                     | DeVilbiss Mexico, S.A. de C.V., Tlalnepantla, Mexico           |
| * DeVilbiss G.m.b.H. Dietzenbach, West Germany        | Toussaint-DeVilbiss & Cie., Valence (Cedex), France            |
| DeVilbiss (Japan) Co., Ltd., Tokyo, Japan             | * DeVilbiss Latinoamerica, Miami, Florida, U.S.A.              |
| * DeVilbiss Europa G.m.b.H. Dietzenbach, West Germany | Thermax DeVilbiss Ltd., Pune, India                            |



## Addendum to SB-2-321-A

### Important Notice

This addendum contains information that supersedes certain data in the existing SB-2-321-A Owner's Manual. Please keep this addendum sheet with your Owner's Manual for future reference when ordering.

#### Supersedes Fig. 4, Pg 5. Accessory - Gauge Test Kit

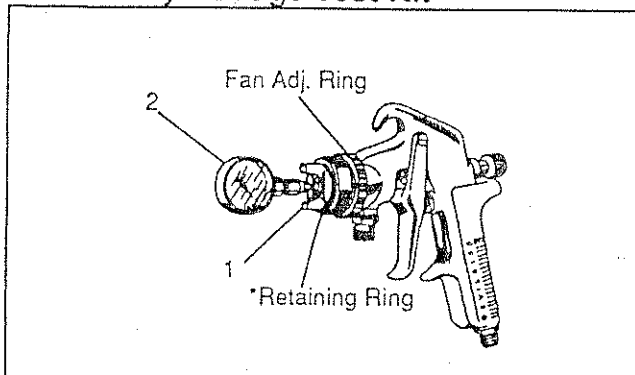

KK-4960 - Use on Models with - 12 air cap  
 KK-4969 - Use on Models with - 142 air cap  
 KK-4970 - Use on Models with - 162 air cap

Ref. No.	Replacement Part No.	Description	Qty.
1	JGHV-429-12	Air Cap (12) with Fitting	1
	JGHV-429-142	Air Cap (142) with Fitting	1
	JGHV-429-162	Air Cap (162) with Fitting	1
2	GA-313	Gauge (0-15 psi)	1

\*Customer must use retaining ring from existing gun.

The purpose of this test kit is too measure air cap atomizing air pressure at the air cap to demonstrate compliance to air quality regulations.

#### Supersedes Chart 1, Pg. 6 Chart 1 Air Cap (2), Fluid Tip (3), Needle (10) Combinations

Gun Model	No. on Cap	Fluid Tip Size		Ordering Number			
		in.	mm	Ref (2)	†Ref (3)	Ref (10) Stainless Steel	Ref (10) Delrin Optional
JGHV-520-12GX	12	GX	.034 0.9	JGHV-16-12	JGHV-601-GX	JGHV-425-GX	JGHV-412-GX
JGHV-520-14FY	142	FY	.039 1.0	JGHV-16-142	JGHV-601-FY	JGHV-425-FY	JGHV-412-GX
JGHV-520-16FF	162	FF	.055 1.4	JGHV-16-162	JGHV-601-FF	JGHV-425-FF	JGHV-412-FF
JGHV-520-16DE		DE	.079 2.0				JGHV-601-DE

† Includes AV-1 gasket (4).